



### VERCO DECKING, INC. a NUCOR Company

4340 North 42nd Avenue  
Phoenix, Arizona 85019  
(602) 272-1347  
[www.vercodeck.com](http://www.vercodeck.com)

### STEEL DECK PANELS

CSI DIVISION: 05 00 00 – METALS  
CSI SECTION: 05 31 00 – STEEL DECK  
05 31 13 – STEEL FLOOR DECKING  
05 31 23 – STEEL ROOF DECKING

### 1.0 RECOGNITION

Steel deck recognized in this report has been evaluated for use as a component of horizontal or sloped floor and roof systems supporting out of plane loads, in-plane diaphragm shears, and in-plane axial loads. Physical characteristic and structural performance properties comply with the intent of the provisions of the following codes and regulations:

- 2018, 2015 and 2012 International Building Code® (IBC)
- 2018, 2015 and 2012 International Residential Code® (IRC)
- 2016 California Building Code (CBC)

### 2.0 LIMITATIONS

Use of the steel deck recognized in this report is subject to the following limitations:

**2.1 Sound Transmission Performance:** Acoustic performance is beyond the scope of this report.

**2.2 Fire-Resistance Ratings:** Fire-resistance performance is beyond the scope of this report.

**2.3** The steel deck shall be installed in accordance with the applicable code, the manufacturer’s published installation instructions, and this report. Where there is a conflict, the most restrictive requirements shall govern.

**2.4** The steel panels recognized in this report are produced by Vercor Decking, Inc. in Phoenix, Arizona; Fontana, California; and Antioch, California.

### 3.0 PRODUCT USE

#### 3.1 General:

It is permissible to use steel deck panels to resist out-of-plane loads, in plane diaphragm shear loads, and axial loads.

#### 3.2 Design:

**3.2.1 Out-of-Plane Strength:** Out-of-plane strength of deck panels shall be determined using engineering mechanics and deck panel properties presented in this report.

Deflections resulting from out-of-plane load shall comply with Section 1604.3 of the IBC.

**3.2.2 Composite Steel Deck-Slabs:** Composite steel deck-slab out-of-plane load strength (superimposed loads) shall be determined in accordance with ANSI/SDI C-2017 using properties and composite coefficients in this report. In accordance with ACI 318-14 26.4.1.4.1(c) or ACI 318-11 3.6.4, calcium chloride or admixtures containing chloride from sources other than impurities in admixture ingredients are prohibited from use in concrete cast against stay-in-place galvanized steel deck.

**3.2.3 Reactions:** The strength of steel deck panels to resist reaction loads at supports and locations of concentrated loads shall be determined based on the either web crippling strength or web shear strength. Web crippling strength shall be determined in accordance with AISI S100-16 Section G5 and the properties in this report. Deck panel web shear strength of deck panel webs shall be determined in accordance with AISI S100-16 Section G2.1 and the properties in this report. The strength of web-perforated deck panels shall be determined in accordance with the equations in this report.

**3.2.4 In-Plane (Diaphragm) Shear Strength and Stiffness:** The in-plane shear strength of steel roof deck, non-composite steel deck, or composite steel deck-slabs shall be determined in accordance with AISI S310-16 including the modifications and properties in this report.

**3.2.5 Axial Strength:** The axial strength or combined axial and bending strength of steel deck panels shall be determined in accordance with AISI S100-16 using the properties in this report.

The product described in this Uniform Evaluation Service (UES) Report has been evaluated as an alternative material, design or method of construction in order to satisfy and comply with the intent of the provision of the code, as noted in this report, and for at least equivalence to that prescribed in the code in quality, strength, effectiveness, fire resistance, durability and safety, as applicable, in accordance with IBC Section 104.11. This document shall only be reproduced in its entirety.





**3.2.6 Wall Bracing:** The design for anchorage of structural walls and transfer of anchorage forces into the diaphragm shall be in accordance with Section 12.11.2 of ASCE/SEI 7, subject to the following limitations:

1. Transfer of anchorage forces into diaphragm shall be in the direction parallel to the flutes (ribs) of the steel deck.
2. When acting as the continuous ties or struts between diaphragm chords, anchorage forces shall be distributed into the diaphragm in the direction parallel to the flutes (ribs) of the steel deck.
3. Combined axial load and bending shall be considered in accordance with Section H1 of AISI S100-16 to determine the strength of steel deck (without concrete fill) used to resist wall anchorage forces or to resist continuous tie forces parallel to the flutes (ribs).
4. Power-actuated fasteners, self-drilling screws, or welded connections described in this report are permitted to provide positive means of attachment to satisfy the connection requirements in ASCE/SEI 7 Section 12.11.2.2.1.

**3.2.7 Partial Panels, Openings, Holes or Penetrations through Steel Deck:** The registered design professional may submit design calculations and details to the building official for approval based on the principles of engineering mechanics for partial panels, openings, holes or penetrations. For lateral force resisting systems, the calculations shall consider the effects of partial panels, openings, holes, or penetrations on the overall strength and stiffness of the diaphragm.

**3.2.8 Supporting Member Materials:** Supporting members shall comply with the requirements of AISI S310-16.

### 3.2.9 Connections:

**3.2.9.1 Self-Drilling Screws:** Self-drilling screws may be used to attach steel deck panels to supporting members and to attach the sidelaps of steel deck panels to each other in accordance with AISI S100 and AISI S310 unless described in this report. The screws shall be manufactured in accordance with SAE J78 and shall be compliant with ASTM C1513.

**3.2.9.2 Power Actuated Fasteners (PAF's):** Power actuated fasteners may be used to attach steel deck panels to supporting members in accordance with this report. The fasteners shall be designed to attach steel deck panels to supporting members and shall be described in a current evaluation report issued by an approved and accredited evaluation service.

**3.2.9.3 Welds:** Welds may be used to attach steel deck panels to supporting members and to attach the sidelaps of steel deck panels to each other in accordance with AISI S100-

16 and AISI S310-16. The minimum tensile strength of the weld filler shall be designated as a minimum of 60 ksi (413.7 MPa) and comply with the appropriate AWS standard.

**3.2.9.4 Non-Piercing Button Punch:** Non-piercing button punch may be used to attach the sidelaps of steel deck panels to each other in accordance with AISI S310-16.

**3.2.9.5 PunchLok® II System:** The PunchLok II system consists of PunchLok deck described in this report connected at sidelaps with the Vulcraft/Verco Group proprietary connection. Acoustical versions of the listed deck sections may also be used. The proprietary connection is referred to as the "Vulcraft/Verco Sidelap Connection 2" (VSC2), and is an interlocking connection between the male and female lips of the appropriate deck. A VSC2 connection is made in either direction relative to the female lip. A VSC2 connection is made when the sidelap material has been sheared and offset so the sheared surface of the steel deck panel male lip is visible. This punched portion measures 0.45 inch (11.4 mm) – 0.70 inch (17.8 mm) nominal width by 0.30 inch (7.6 mm) nominal height. The PunchLok II system shall be installed in accordance with Vulcraft/Verco Group instructions. The resulting VSC2 connection is illustrated on page 8 of this report.

### 3.3 Installation:

Steel deck panel erection sequence and installation method is the responsibility of the contractor(s) performing installation of the steel deck panels. Installation shall be in accordance with this report, ANSI/SDI RD-2017, ANSI/SDI NC-2017 and ANSI/SDI C-2017 and all welds shall comply with AWS D1.3. Where conflicts occur, the more restrictive shall govern. Additional installation information is available in the Steel Deck Institute (SDI MOC) Manual of Construction with Steel Deck and manufacturer's recommendations. Mechanical fasteners shall be installed in accordance with the manufacturer's current evaluation report issued by an approved and accredited evaluation service. Quality control during installation shall comply with ANSI/SDI QA/QC.

### 3.4 Inspections:

**3.4.1 General:** Special inspection is required in accordance with IBC Chapter 17. Quality assurance for deck installation shall comply with ANSI/SDI QA/QC, where the special inspector duties are as set forth for the quality assurance inspector (QAI).

**3.4.2 Jobsite Welding:** Periodic special inspection for welding shall be in accordance with IBC Chapter 17. Prior to proceeding, the welder shall demonstrate the ability to produce the prescribed weld to the special inspector's satisfaction. The inspector's duties include verification of materials, weld preparation, welding procedures, and welding processes.



**3.4.3 Concrete:** Continuous and periodic special inspection for concrete and concrete reinforcement shall be in accordance with Section 1705.3 of the IBC. The inspector's duties include sampling and testing, and verification of concrete mixes, reinforcement types and placement, and concrete placement.

**3.4.4 Periodic Special Inspection:** Periodic special inspections for weld, screw and power-actuated fastener connections are required where the steel deck systems are used in a seismic-force-resisting system in structures assigned to Seismic Design Category C, D, E or F; or a wind-force resisting system in areas described in IBC Chapter 17.

#### 4.0 PRODUCT DESCRIPTION

**4.1 Steel Deck Panels:** The steel deck panels described in this report are cold-formed from steel sheets into panels with fluted sections having galvanized, phosphatized/painted, painted/painted, or mill finishes. Panel characteristics including profile designation, sidelap type, applicable sidelap fasteners and perforation for fluted profiles are described in the tables and figures that accompany this report.

The galvanized deck panels are formed from either ASTM A653 or A1063 steel, with a minimum G30 galvanized coating designation. The phosphatized/painted, painted/painted, or mill finished steel deck panels are formed from either ASTM A1008 or A1039 steel. Phosphatized/painted deck panels have a phosphatized (uncoated) top surface and primer painted bottom surface.

Painted/painted deck panels have primer painted top and bottom surfaces. Mill-finished deck panels have no coating on either top or bottom surfaces.

Verco® and PunchLok® are registered trademarks of Nucor Corporation or its affiliates.

**4.2 Concrete:** Concrete shall be either lightweight concrete or normal weight concrete and comply with Chapter 19 of the IBC. In accordance with ACI 318-14 26.4.1.4.1(c) or ACI 318-11 3.6.4, calcium chloride or admixtures containing chloride from sources other than impurities in admixture ingredients are prohibited from use in concrete cast against stay-in-place galvanized steel deck or embedded items. The minimum compressive strength shall be as indicated in the tables and figures of this report.

#### 5.0 IDENTIFICATION

Each bundle of decking is marked with labels with the Verco Decking, Inc. name, the deck type, the minimum base-metal thickness (uncoated), minimum specified yield strength and the IAPMO Uniform Evaluation Report number ER-2018.

The cellular deck panel labeling also includes the manufacturing location (Antioch, CA).

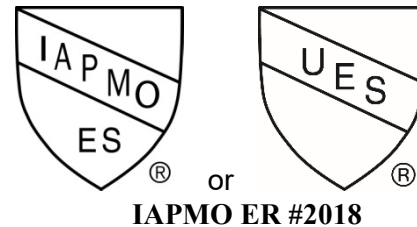

#### 6.0 SUBSTANTIATING DATA

Data in accordance with the IAPMO Uniform Evaluation Service Evaluation Criteria EC-007, Adopted April 2019, Evaluation Criteria for Steel Composite, Non-composite, and Roof Deck Construction.

#### 7.0 STATEMENT OF RECOGNITION

This evaluation report describes the results of research carried out by IAPMO Uniform Evaluation Service on Vulcraft/Verco Group Steel Floor Decking and Steel Roof Decking.

*Brian Gerber*

**Brian Gerber, P.E., S.E.**  
**Vice President, Technical Operations**  
**Uniform Evaluation Service**

*Richard Beck*

**Richard Beck, PE, CBO, MCP**  
**Vice President, Uniform Evaluation Service**

*Russ Chaney*

**GP Russ Chaney**  
**CEO, The IAPMO Group**



## CALIFORNIA SUPPLEMENT

### VERCO DECKING, INC. a NUCOR Company

4340 North 42nd Avenue

Phoenix, Arizona 85019

(602) 272-1347

[www.vercodeck.com](http://www.vercodeck.com)

## STEEL DECK PANELS

CSI DIVISION: 05 00 00 – METALS

CSI SECTION: 05 31 00 – STEEL DECK

05 31 13 – STEEL FLOOR DECKING

05 31 23 – STEEL ROOF DECKING

## 1.0 RECOGNITION

Verco Decking Inc. Steel Deck Panels described in IAPMO UES ER-2018 and this supplement have been evaluated for use as components of floor and roof systems. The structural properties of the steel deck panels were evaluated for compliance with the following codes and regulations:

- 2016 California Building Code (CBC)

## 2.0 LIMITATIONS

Use of the Verco Steel Deck Panels recognized in this report is subject to the following limitations:

- 2.1 Diaphragm deflections shall not exceed the permitted relative deflection of walls between the

diaphragm level and the floor below. The flexibility limitations shown in Table 1604A.4 of the 2016 California Building Code may be used as a guide in lieu of a rational analysis of the anticipated deflections.

- 2.2 As applicable, in accordance with CBC Section 2210A.1.1.2, the minimum base steel thickness of the steel deck shall be 0.0359 inches (0.9 mm), except for single-story open structures, where the steel deck is not used as a diaphragm and there are no suspended hangers or bracing for nonstructural components attached to the deck.
- 2.3 Special Inspections are required in accordance with CBC Sections 1705.2 and 1705A.2, Steel Construction; and CBC Sections 1705.3 and 1705A.3, Concrete Construction.
- 2.4 Structural Observation is required in accordance with CBC Sections 1704.6 and 1704A.6.
- 2.5 Concrete tests and materials shall comply with CBC Sections 1909.2, 1903A, and 1910A, as applicable.

For additional information about this evaluation report please visit [www.uniform-es.org](http://www.uniform-es.org) or email at [info@uniform-es.org](mailto:info@uniform-es.org)



# EVALUATION REPORT

Number:

**2018**

Originally Issued: 07/11/2019

Valid Through: 07/31/2020  
Page 5 of 47

Page reserved for future use.



### TABLE OF CONTENTS

Subject	Page
Profile Characteristics	7
Embossed Profiles	8
Sidelap Types	8
Perforated Profiles	9
Connections Through Perforated Material	10
Composite Steel Deck-Slab Coefficient, K	10
Diaphragm Shear Strength	11
Proprietary Connections	12-15
Maximum Diaphragm Shear between Openings Reinforced with Cold-Formed Steel Curbs	16
PLB-36 and HSB-36 Roof Deck Spans for Concentrated Loads	17
ITW Buildex SAMMYS X-Press Swivel Head <sup>®</sup> Connection	18
Definitions of Section Property Symbols	19-20
Panel Properties	21-47
PLB-36, HSB-36, HSB-36-SS, PLB-36 FormLok, B-36 FormLok, B-36-SS FormLok	21
HSBR-30-NS, HSBR-36, HSBR-36-SS, BR-36 FormLok, BR-36-SS FormLok	22
PLN3-32, HSN3-32, HSN3-32-SS, HSN3-32-NS, PLN3-32 FormLok, N3-32 FormLok, N3-32-SS FormLok, N3-32-NS FormLok	23
PLN-24, N-24, N-24-SS, PLN-24 FormLok, N-24 FormLok, N-24-SS FormLok	24
PLW2-36 FormLok, W2-36 FormLok, W2-36-SS FormLok	25
PLW3-36 FormLok, W3-36 FormLok, W3-36-SS FormLok	26
9/16 Shallow Vercor, 9/16 Shallow Vercor Inverted	27
1-5/16 Deep Vercor, 1-5/16 Deep Vercor Inverted	28
PLB-36 AC, HSB-36 AC, HSB-36-SS AC	29
PLN3-32 AC, HSN3-32 AC, HSN3-32-SS AC, HSN3-32-NS AC	30
PLN-24 AC, N-24 AC, N-24-SS AC	31
PLB-36 FP11, HSB-36 FP11, HSB-36-SS FP11	32
PLN3-32 FP11, HSN3-32 FP11, HSN3-32-SS FP11	33
PLN-24 FP11, N-24 FP11, N-24-SS FP11	34
PLB-36 FP21, HSB-36 FP21, HSB-36-SS FP21, HSB-30-NS FP21	35
PLN3-32 FP21, HSN3-32 FP21, HSN3-32-SS FP21	36
PLN-24 FP21, N-24 FP21, N-24-SS FP21	37
PLBCD-36, HSBCD-36, PLBCD-36 FormLok, BCD-36 FormLok	38
PLN3CD-32, HSN3CD-32, PLN3CD-32 FormLok, N3CD-32 FormLok	39
PLNCD-24, NCD-24, PLNCD-24 FormLok, NCD-24 FormLok	40
PLW2CD-36 FormLok, W2CD-36 FormLok	41
PLW3CD-36 FormLok, W3CD-36 FormLok	42
PLBCD-36 AC, HSBCD-36 AC, PLBCD-36 AC FormLok, BCD-36 AC FormLok	43
PLN3CD-32 AC, HSN3CD-32 AC, PLN3CD-32 AC FormLok, N3CD-32 AC FormLok	44
PLNCD-24 AC, NCD-24 AC, PLNCD-24 AC FormLok, NCD-24 AC FormLok	45
PLW2CD-36 AC FormLok, W2CD-36 AC FormLok	46
PLW3CD-36 AC FormLok, W3CD-36 AC FormLok	47





PROFILE CHARACTERISTICS										
Profile Designation(s)	Sidelap Type		Sidelap Fastener			Embossed	Cellular	Acoustic		
	Inter-locking	Nestable	VSC2	Screws	Other <sup>1</sup>			Web Perforated	Fully Perforated	Perforated Bottom Pan
PLB-36, PLN3-32, PLN-24	✓		✓							
HSB-36, HSN3-32, N-24	✓				✓					
HSB-36-SS, HSBR-36-SS, HSN3-32-SS, N-24-SS	✓			✓						
HSBR-30-NS, HSN3-32-NS, 9/16 Shallow Vercor, 1-5/16 Deep Vercor		✓		✓	✓					
PLB-36 FormLok, PLN3-32 FormLok, PLN-24 FormLok, PLW2-36 FormLok, PLW3-36 FormLok	✓		✓			✓				
B-36 FormLok, BR-36 FormLok, N3-32 FormLok, N-24 FormLok, W2-36 FormLok, W3-36 FormLok	✓				✓	✓				
B-36-SS FormLok, BR-36-SS FormLok, N3-32-SS FormLok, N-24-SS FormLok, W2-36-SS FormLok, W3-36-SS FormLok	✓			✓		✓				
N3-32-NS FormLok		✓		✓	✓	✓				
PLB-36 AC, PLN3-32 AC, PLN-24 AC	✓		✓				✓			
HSB-36 AC, HSN3-32 AC, N-24 AC	✓				✓		✓			
HSB-36-SS AC, HSN3-32-SS AC, N-24-SS AC	✓			✓			✓			
HSN3-32-NS AC		✓		✓			✓			
PLB-36 FP11, PLB-36 FP21, PLN3-32 FP11, PLN3-32 FP21, PLN-24 FP11, PLN-24 FP21	✓		✓					✓		
HSB-36 FP11, HSB-36 FP21, HSN3-32 FP11, HSN3-32 FP21, N-24 FP11, N-24 FP21	✓				✓			✓		
HSB-36-SS FP11, HSB-36-SS FP21, HSN3-32-SS FP11, HSN3-32-SS FP21, N-24-SS FP11, N-24-SS FP21	✓			✓				✓		
PLBCD-36, PLN3CD-32, PLNCD-24	✓		✓				✓			
HSBCD-36, HSN3CD-32, NCD-24	✓				✓		✓			
PLBCD-36 FormLok, PLN3CD-32 FormLok, PLNCD-24 FormLok, PLW2CD-36 FormLok, PLW3CD-36 FormLok	✓		✓			✓	✓			
BCD-36 FormLok, N3CD-32 FormLok, NCD-24 FormLok, W2CD-36 FormLok, W3CD-36 FormLok	✓				✓	✓	✓			
PLBCD-36 AC, PLN3CD-32 AC, PLNCD-24 AC	✓		✓				✓			✓
HSBCD-36 AC, HSN3CD-32 AC, NCD-24 AC	✓				✓		✓			✓
PLB-CD AC FormLok, PLN3-CD AC FormLok, PLN-CD AC FormLok, PLW2-CD AC FormLok, PLW3-CD AC FormLok	✓		✓			✓	✓			✓
BCD-36 AC FormLok, N3CD-32 AC FormLok, NCD-24 AC FormLok, W2CD-36 AC FormLok, W3CD-36 AC FormLok	✓				✓	✓	✓			✓

1. Other = Top arc seam sidelap welds or non-piercing button punch sidelap connections for interlocking profiles and arc spot or fillet welds for nestable profiles.



EMBOSSED PROFILES		
Profiles	End View	Side View
PLB FormLok, HSB FormLok, B FormLok-SS, BR FormLok-SS, PLB-CD FormLok, B-CD FormLok, PLB-CD AC FormLok, B-CD AC FormLok		
PLN3 FormLok, N3 FormLok, N3 FormLok-SS, N3 FormLok-NS, PLN3-CD FormLok, HSN3-CD FormLok, PLN3-CD AC FormLok, HSN3-CD AC FormLok		
PLN FormLok, N FormLok, N FormLok-SS, PLN-24-CD FormLok, N-CD FormLok, PLN-CD AC FormLok, N-CD AC FormLok		
PLW2 FormLok, W2 FormLok, W2 FormLok-SS, PLW2-CD FormLok, W2-CD FormLok, PLW2-CD AC FormLok, W2-CD AC FormLok		
PLW3 FormLok, W3 FormLok, W3 FormLok-SS, PLW3-CD FormLok, W3-CD FormLok, PLW3-CD AC FormLok, W3-CD AC FormLok		

SIDELAP TYPES			
Interlocking (PunchLok II, Other)	Interlocking (Screwed Sidelap)	Nestable (Screwed Sidelap)	Nestable (Vercor)





### PERFORATED PROFILES

#### Perforated Web Reduction Factor

The perforated web reduction factor,  $q_s$ , is calculated as follows:

$$q_s = 1 - (1 - k) \left( \frac{W_p}{h_w} \right) \quad [\text{Eq. W-1}]$$

$$p_o = 0.9069 \left( \frac{d_p^2}{c_p^2} \right) \quad [\text{Eq. W-2}]$$

$$\begin{aligned} k &= 1 - 2.175p_o \text{ for } p_o < 0.20 \\ k &= 0.9 + p_o^2 - 1.875p_o \text{ for } 0.20 \leq p_o \leq 0.58 \end{aligned} \quad [\text{Eq. W-3}]$$

Where:

$q_s$  = Perforated web reduction factor

$k$  = Ratio of stiffness

$W_p$  = Width of perforated band in web, in.

$h_w$  = Flat dimension of web measured in plane of web, in.

$p_o$  = Percentage of open area

$d_p$  = Diameter of perforation hole, in.

$c_p$  = Perforation hole center-to-center spacing, in.

#### Shear Strength of Profiles with Perforated Webs

The vertical shear strength for profiles with perforated webs shall be calculated as follows:

$$V_{np} = q_s n_w V_n \sin\theta \quad [\text{Eq. W-4}]$$

Where:

$V_{np}$  = Vertical shear strength of profile with perforated web, kip/ft

$n_w$  = Number of webs per foot

$V_n$  = The nominal shear strength of solid web calculated in accordance with AISI S100-16 Sec. G2.1, kips

$\theta$  = Angle between plane of web and plane of bearing surface, deg

#### Web-Crippling Strength of Profiles with Perforated Webs

The web-crippling strength of a perforated web shall be calculated in accordance with AISI S100-16 Sec. G5 with the following modifications:

$$P_n = Ct^2 F_y \cdot \sin\theta \cdot \left( 1 - C_R \sqrt{\frac{R}{t}} \right) \left( 1 + C_N \sqrt{\frac{N}{t}} \right) \left( 1 - C_h \sqrt{\frac{h_w}{q_s t}} \right) \quad [\text{AISI S100-16 Eq. G5-1}]$$

*(Modified)*

All variables are as defined in AISI S100-16 Section G5



CONNECTIONS THROUGH PERFORATED MATERIAL <sup>1</sup>						
Fastener Property	Fastener	Adjustment Factor, $\rho$	Individual Connections		Diaphragms	
			$\Omega$ (ASD)	$\phi$ (LRFD)	$\Omega$ (ASD)	$\phi$ (LRFD)
Nominal Shear Strength	Screw	1.00	3.00	0.50	Per AISI S310 Table B1.1	
	PAF <sup>2</sup>	$2.76t + 0.58 \leq 1.00$	2.75	0.60		
	Weld <sup>3</sup>	$0.99d + 0.05 \leq 1.00$	2.80	0.55		
Nominal Pullover Strength	Screw, PAF	0.85	3.00	0.50		
Nominal Tension Strength	Weld <sup>2,4</sup>	$0.19tF_u + 0.11 \leq 1.00$	3.00	0.50		
Flexibility	Screw	1.71	-			
	PAF	1.15				
	Weld	1.00				

<sup>1</sup> For connections through perforated material, multiply calculated fastener property by appropriate adjustment factor.

<sup>2</sup>  $t$  = Base steel thickness of panel (in.)

<sup>3</sup>  $d$  = Visible diameter of arc spot weld (in.)

<sup>4</sup>  $F_u$  = Ultimate strength of sheet steel (ksi)

### **COMPOSITE STEEL DECK-SLAB COEFFICIENT, K**

The flexural strength for composite steel floor deck slabs utilizing steel deck panels be designed in accordance with ANSI/SDI C-2017 Section A2.2 where:

$$K = 2.03 - 1.31 \left( \frac{h_c}{h - y_b} \right) \geq K_{min} \quad [\text{Eq. K-1}]$$

Where:

$h_c$  = Thickness of concrete cover (in.)

$h$  = Total thickness of deck slab (in.)

$y_b$  = Distance from extreme bottom fiber to neutral axis of gross section (in.)

$K_{min}$  = Minimum composite steel-deck slab coefficient per section property tables



### DIAPHRAGM SHEAR STRENGTH AND STIFFNESS

Diaphragm shear strength and stiffness shall be calculated per AISI S310-16 with the following modifications:

#### **D1 Diaphragm Shear Strength per Unit Length Controlled by Connection Strength, $S_{nf}$**

The nominal shear strength [resistance] per unit length of a diaphragm controlled by connection strength,  $S_{nf}$ , shall be the smallest of  $S_{nc}$ ,  $S_{ne}$ , and  $S_{np}$ .

$$S_{np} = \text{minimum} \left( n_d P_{nf} \frac{12}{w_t} \right) \quad \begin{array}{l} \text{[Eq. D1-4a]} \\ \text{For Fluted Panels} \end{array} \quad S_{np} = NP_{nf} \quad \begin{array}{l} \text{[Eq. D1-4b]} \\ \text{For Cellular Deck} \end{array}$$

Where

- $S_{np}$  = Nominal shear strength [resistance] per unit length of diaphragm controlled by connections along the edge perpendicular to the panel span and located at exterior support, kip/ft
- $n_d$  = Number of support connections at any given bottom flute along a panel end perpendicular to the panel span and located at exterior support
- $w_t$  = Greatest tributary width to any given bottom flute with support connections along the edge perpendicular to the panel span and located at exterior support, in.

All other variables are as defined in AISI S310-16 Section D1

#### **D2.1 Fluted Panel**

The nominal diaphragm shear strength [resistance] per unit length,  $S_{nb}$ , for either acoustic or non-acoustic fluted panels shall be the smallest of  $S_{no}$ , and  $S_{nl}$ .

$$S_{no} = \alpha \frac{7890}{L_v^2} \left( \frac{I_{xg}^3 t^3 d}{s} \right)^{0.25} \quad \text{[Eq. D2.1-1]} \quad S_{nl} = P_n \frac{d - e}{D_d} \left( \frac{12}{d} \right) \quad \text{[Eq. D2.1-2]}$$

Where

- $\alpha = 1.00$  for panels fastened to support at every bottom flute at exterior supports
- $0.75$  for panels not fastened to support at every bottom flute at exterior supports
- $S_{no}$  = Nominal diaphragm shear strength [resistance] per unit length controlled by panel out-of-plane buckling, kip/ft
- $S_{nl}$  = Nominal diaphragm shear strength [resistance] per unit length controlled by exterior support local web buckling, kip/ft
- $d$  = Panel corrugation pitch, in.
- $e$  = One-half the bottom flat width of panel measured between points of intercept, in.
- $D_d$  = Depth of panel, in.

$$P_n = 4.36t^2 F_y \cdot \sin \theta \cdot \left( 1 - 0.04 \sqrt{\frac{R}{t}} \right) \left( 1 + 0.25 \sqrt{\frac{N_e}{t}} \right) \left( 1 - 0.025 \sqrt{\frac{h_w}{q_s t}} \right) \quad \text{[Eq. D2.1-3]}$$

Where

- $t$  = Base steel thickness of panel, in.
- $F_y$  = Design yield stress, ksi
- $\theta$  = Angle between plane of web and plane of bearing surface, deg.
- $R$  = Inside bend radius, in.
- $N_e$  = Bearing Length at end of panel support, in.
- $h_w$  = Flat dimension of web measured in plane of web, in.
- $q_s$  = Perforated web reduction factor

#### **D5.1.1 Stiffness of Fluted Panels**

The diaphragm stiffness,  $G'$  shall be calculated in accordance with modified AISI S310-16 Eq. D5.1.1-1

$$G' = \left( \frac{Et}{1(1 + \mu) \frac{s}{d} + \gamma_c \alpha D_n + C} \right) K \quad \text{[Eq. D5.1.1-1]} \quad \begin{array}{l} \text{Where } \alpha = 1.00 \text{ for panels with butted end laps at both ends} \\ \quad \quad \quad 0.50 \text{ for panels with butted end laps at one end} \\ \quad \quad \quad 0.00 \text{ for panels with lapped end laps at both ends} \end{array}$$

For spacing of fasteners connecting panels along longitudinal edges parallel to the deck flutes greater than the interior side-lap seam fastener spacing:

$$d_e \leq \frac{S_s}{S_f} d_s \quad \text{[Eq. G]}$$

Where:

- $d_e$  = Spacing of parallel edge fasteners
- $d_s$  = Spacing of sidelap fasteners
- $S_s$  = Sidelap connection flexibility (in/kip)
- $S_f$  = Structural support connection flexibility (in/k)

### PROPRIETARY FASTENERS

#### **PunchLok II System**

The nominal shear strength [resistance] for PunchLok II System (VSC2) connection shall be determined in accordance with Eq. PL-1:

$$P_{ns} = 137.42 \cdot t - 2.01 \quad [\text{Eq. PL-1}]$$

The flexibility of PunchLok II System (VSC2) connection shall be determined in accordance with Eq. PL-2:

$$S_s = \frac{0.012}{1000 \cdot t^2} \quad [\text{Eq. PL-2}]$$

- ① PunchLok® II system connection - as shown the 2 deformations of male and female sheets are projecting through the female sheet. However, the VSC2 may be made in either direction
- ② Sheared surface of male leg.
- ③ Sheared surface of female leg.
- ④ Male leg / sheet.
- ⑤ Female leg / sheet.

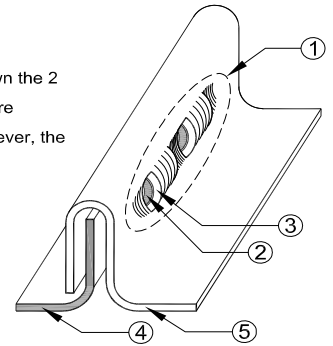

#### **Simpson Strong-Tie**

The nominal shear strength [resistance] for the Simpson XL Screw shall be determined in accordance with Eq. S-1:

$$P_{nf} = 78 \cdot t \cdot (t_{\text{support}})^{0.15} \leq P_{nvs} \quad [\text{Eq. S-1}]$$

The nominal shear strength [resistance] for the Simpson XM Screw shall be determined in accordance with Eq. S-2a or S-2b:

$$\text{For } t_{\text{support}} \leq 0.1875 \text{ in} \quad P_{nf} = 240 \cdot (t)^{1.5} \leq P_{nvs} \quad [\text{Eq. S-2a}]$$

$$\text{For } t_{\text{support}} > 0.1875 \text{ in} \quad P_{nf} = 53 \cdot t \leq P_{nvs} \quad [\text{Eq. S-2b}]$$

The nominal shear strength [resistance] for the Simpson X1S1016 or XQ1S1016 shall be determined in accordance with Eq. S-3:

$$P_{ns} = 20 \cdot t \leq 1.625 \quad [\text{Eq. S-3}]$$

The nominal shear strength [resistance] for the Simpson XU34B1016 shall be determined in accordance with Eq. S-4:

$$P_{ns} = 25.2 \cdot t \leq 1.735 \quad [\text{Eq. S-4}]$$

Where:

$t$  = Base steel thickness of panel (in.)

$t_{\text{support}}$  = Thickness of support (in.)

$S_s$  = Sidelap connection flexibility (in/kip)

$S_f$  = Structural support connection flexibility (in/k)

$P_{nf}$  = Nominal shear strength [resistance] of a support connection (kips)

$P_{ns}$  = Nominal shear strength [resistance] of a side-lap connection per fastener (kips)

$P_{nvs}$  = Nominal shear strength [resistance] of screw (see page 11)



### PROPRIETARY FASTENERS (Continued)

#### Hilti

The nominal shear strength [resistance] for the Hilti X-ENP-19 L15 PAF shall be determined in accordance with Eq. H-1:

$$P_{nf} = 56 \cdot t \cdot (1 - t) \leq P_{nvp} \quad [\text{Eq. H-1}]$$

The nominal shear strength [resistance] for the Hilti X-HSN24 PAF shall be determined in accordance with Eq. H-2:

$$P_{nf} = 52 \cdot t \cdot (1 - t) \leq P_{nvp} \quad [\text{Eq. H-2}]$$

The flexibility of the Hilti X-ENP-19 L15 and X-HSN24 PAF shall be determined in accordance with Eq. H-3:

$$S_f = \frac{1.25}{1000\sqrt{t}} \quad [\text{Eq. H-3}]$$

The nominal tension strength [resistance] for the Hilti X-HSN 24 controlled by pull-out shall be determined in accordance with Eq. H-4:

$$P_{not} = 8 \cdot t_{\text{support}} + 0.088 \leq 1.875 \quad \Omega = 2.50 \text{ (ASD)} \quad \phi = 0.65 \text{ (LRFD)} \quad \phi = 0.55 \text{ (LSD)} \quad [\text{Eq. H-4}]$$

The nominal tension strength [resistance] for the X-ENP-19 L15 controlled by pull-out shall be determined in accordance with Eq. H-5:

$$P_{not} = 2.625 \quad \Omega = 2.50 \text{ (ASD)} \quad \phi = 0.65 \text{ (LRFD)} \quad \phi = 0.55 \text{ (LSD)} \quad [\text{Eq. H-5}]$$

Where:

t = Base steel thickness of panel (in.)

t<sub>support</sub> = Thickness of support (in.)

S<sub>f</sub> = Structural support connection flexibility (in/k)

P<sub>nf</sub> = Nominal shear strength [resistance] of a support connection (kips)

P<sub>ns</sub> = Nominal shear strength [resistance] of a side-lap connection per fastener (kips)

P<sub>nvp</sub> = Nominal shear strength [resistance] of PAF (see page 11)

P<sub>not</sub> = Nominal tensile strength [resistance] of a support connection per fastener controlled by pull-out (kips)

φ = Resistance Factor

Ω = Safety Factor



### PROPRIETARY FASTENERS (Continued)

#### **Pneutek**

The nominal shear strength [resistance] for the Pneutek SDK61 PAF shall be determined in accordance with Eq. P-1a and P-1b:

For substrate thickness equal to 0.113"

$$P_{nf} = 0.735 \cdot t \cdot F_u(1 - 0.016 \cdot t \cdot F_u) \leq P_{nvp} \quad [\text{Eq. P-1a}]$$

For substrate thickness equal to 0.155"

$$P_{nf} = 0.788 \cdot t \cdot F_u(1 - 0.028 \cdot t \cdot F_u) \leq P_{nvp} \quad [\text{Eq. P-1b}]$$

For substrate thickness between 0.113" and 0.155",  $P_{nf}$  shall be determined by interpolation.

The nominal shear strength [resistance] for the Pneutek SDK63, K64 and K66 PAF shall be determined in accordance with Eq. P-2:

$$P_{nf} = 1.264 \cdot t \cdot F_u(1 - 0.053 \cdot t \cdot F_u) \leq P_{nvp} \quad [\text{Eq. P-2}]$$

The flexibility of the Pneutek SDK61 PAF shall be determined in accordance with Eq. P-3:

$$S_f = \frac{3}{1000\sqrt{t}} \quad [\text{Eq. P-3}]$$

The flexibility of the Pneutek SDK63, K64 and K66 PAF shall be determined in accordance with Eq. P-4a and P-4b:

For substrate thickness less than 0.25"

$$S_f = \frac{3}{1000\sqrt{t}} \quad [\text{Eq. P-4a}]$$

For substrate thickness equal to or greater than 0.25"

$$S_f = \frac{1}{1000\sqrt{t}} \quad [\text{Eq. P-4b}]$$

The nominal tension strength [resistance] for the Pneutek SDK61, SDK63, K64 and K66 PAF controlled by pull-out shall be determined in accordance with Eq. P-5:

$$P_{not} = 18.37 \cdot t_{support} \leq 4.811 \quad \Omega = 2.45 \text{ (ASD)} \quad \phi = 0.65 \text{ (LRFD)} \quad \phi = 0.55 \text{ (LSD)} \quad [\text{Eq. P-5}]$$

Where:

$P_{not}$  = Nominal tensile strength [resistance] of a support connection per fastener controlled by pull-out (kips)

$P_{nf}$  = Nominal shear strength [resistance] of a support connection per fastener (kips)

$t$  = Base steel thickness of panel (in.)

$F_u$  = Ultimate strength of sheet steel (ksi)

$P_{nvp}$  = Nominal shear strength [resistance] of PAF (see page 11)

$t_{support}$  = Thickness of support (in.)

$S_f$  = Structural support connection flexibility (in/k)

$\phi$  = Resistance Factor

$\Omega$  = Safety Factor





PROPRIETARY SUPPORT FASTENER PROPERTIES <sup>1-2</sup>								
Specified Properties	Hilti		Pneutek				Simpson Strong-Tie	
	X-HSN 24	X-ENP-19	SDK61	SDK63	K64	K66	XM Screw	XL Screw
Minimum Substrate Thickness (in)	0.125	0.250	0.113	0.155	0.187	0.281	0.125	0.125
Maximum Substrate Thickness (in)	0.375	∞	0.155	0.250	0.312	∞	0.610	0.610
Minimum Spacing <sup>1,2</sup>	1"	1"	1"	1"	1"	1"	11/16"	11/16"
Minimum Edge Distance <sup>1,2</sup>	1/2"	1/2"	1/2"	1/2"	1/2"	1/2"	3/8"	3/8"
Shank Diameter (in)	0.157	0.177	0.144	0.173	0.181	0.199	0.216	0.216
Head or Washer Diameter (in)	0.474	0.591	0.500	0.500	0.500	0.500	0.483	0.625
Tensile Strength based on Material strength (kip)	5.033	6.397	3.909	5.641	6.175	7.465	4.985	4.985
Nominal Shear Strength of Screw, P <sub>nvs</sub> (kip)	-	-	-	-	-	-	3.110	3.110
Nominal Shear Strength of PAF, P <sub>nvp</sub> (kip)	3.020	3.838	2.345	3.385	3.705	4.479	-	-

<sup>1</sup> Minimum spacing and edge distance for Screws are determined in accordance with AISI S100-16 Section J4.1 and J4.2 respectively.

<sup>2</sup> Minimum spacing and edge distance for PAF's are determined in accordance with AISI S100-16 Table J5.1-1



MAXIMUM DIAPHRAGM SHEAR BETWEEN OPENINGS REINFORCED WITH COLD-FORMED STEEL CURBS <sup>1,2a-f</sup>							
Deck Profile	Deck Gage	ASD - Allowable Diaphragm Shear, $S_n/\Omega$ (plf)			ASD - Allowable Diaphragm Shear, $\phi S_n$ (plf)		
		Span Length (ft-in)			Span Length (ft-in)		
		6'-0"	8'-0"	10'-0"	6'-0"	8'-0"	10'-0"
PLB-36 HSB-36	22	1127	1116	-	1831	1814	-
	20	1408	1398	1313	2288	2272	2134
	18	1929	1920	1914	3135	3120	3110

<sup>1</sup>  $S_n$  = Nominal shear strength [resistance] per unit length of diaphragm system

<sup>2</sup> Roof openings may be reinforced with cold-formed steel curbs on top of the steel roof deck without below deck support frames, as shown in below subject to the following conditions a-f:

- <sup>a</sup> The diaphragm shear strengths shall not exceed the lesser of this table or the calculated shear strength.
- <sup>b</sup> Opening shall span between joists or beams shown in figure below.
- <sup>c</sup> Cold-formed steel curbs be shall be a minimum of ASTM A653 Commercial Quality or equivalent steel specification.
- <sup>d</sup> Cold-Formed steel curbs shall meet the dimensions as shown in figure below.
- <sup>e</sup> Cold-Formed steel curbs shall have the minimum attachments to the steel roof deck as shown in figure below.
- <sup>f</sup> Deck may be end lapped, butted, or continuous between openings.

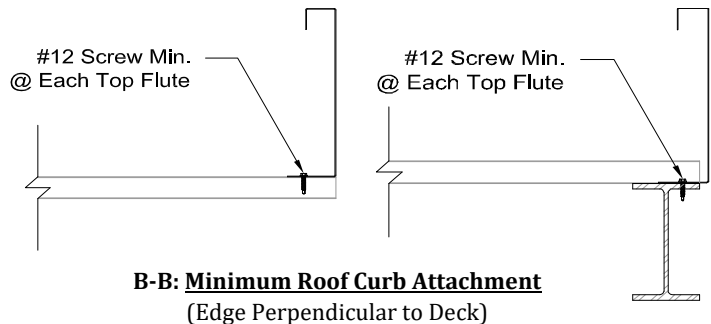
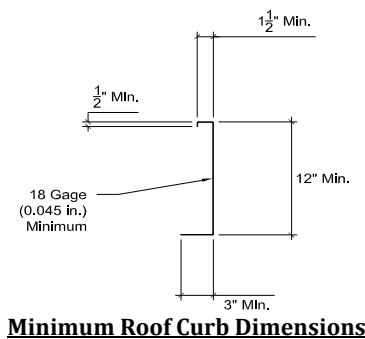
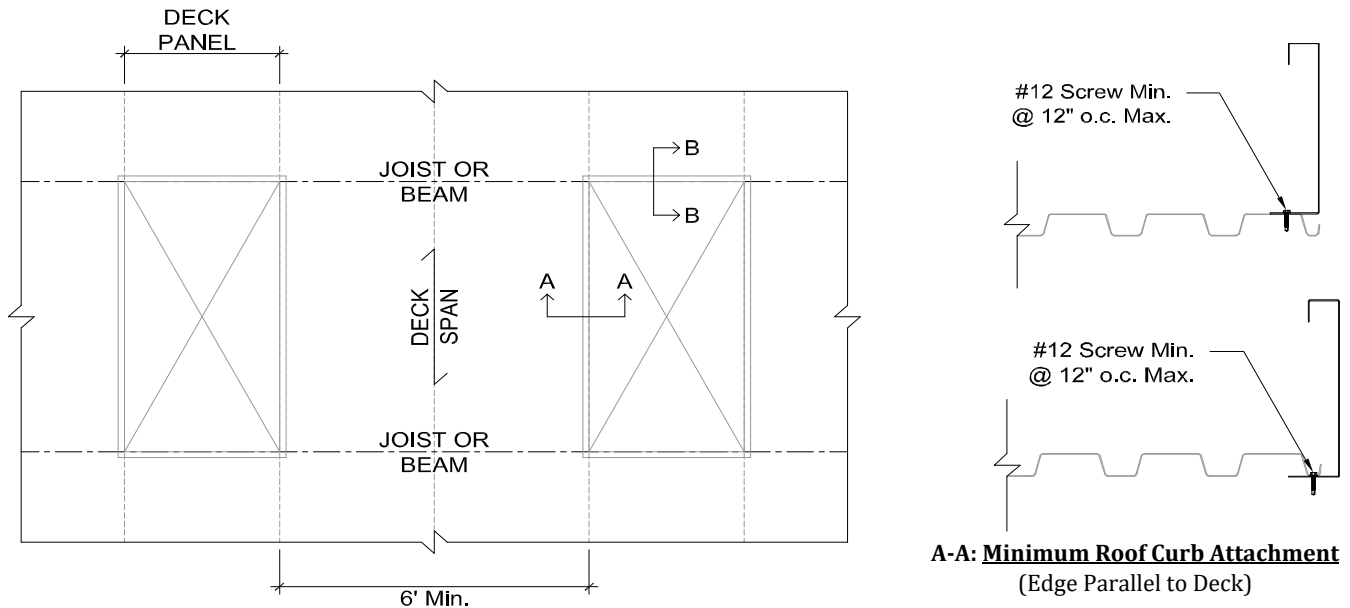



PLB-36 AND HSB-36 ROOF DECK SPANS FOR CONCENTRATED LOADS <sup>1-5</sup>					
Deck Gage	Number of Spans	Maximum Span			
		Strength $P_n/\Omega$	Insulation		
			L / 360	L / 240	L / 180
22	1	12'-7"	7'-5"	9'-5"	11'-5"
	2	17'-0"	7'-10"	10'-11"	13'-0"
	3	≥ 14'-0"	7'-10"	10'-11"	12'-11"
20	1	15'-5"	8'-4"	11'-0"	13'-8"
	2	20'-5"	10'-0"	13'-8"	15'-11"
	3	≥ 14'-0"	10'-4"	≥ 14'-0"	≥ 14'-0"
18	1	19'-5"	9'-10"	12'-11"	15'-2"
	2	≥ 21'-0"	12'-1"	15'-10"	17'-4"
	3	≥ 14'-0"	12'-1"	≥ 14'-0"	≥ 14'-0"
16	1	23'-2"	11'-0"	15'-5"	18'-10"
	2	≥ 21'-0"	13'-10"	19'-6"	≥ 21'-0"
	3	≥ 14'-0"	14'-0"	≥ 14'-0"	≥ 14'-0"

<sup>1</sup> Strength values based on a 300 lbs concentrated roof live load and 5 psf uniform dead load.

<sup>2</sup> Deflection values based on a 300 lbs concentrated roof live load.

<sup>3</sup> Concentrated load distributed over a 2-1/2ft x 2-1/2ft per IBC section 1607.4.

<sup>4</sup> Concentrated load deflections based on an assembly that includes a minimum of 2 layers of 1-1/2" ASTM C 1289, Type II, Class 1, Grade 2 (20 psi) polyisocyanurate insulation board on the steel deck.

<sup>5</sup> Table is limited to the maximum available sheet length of 42'-0". For longer sheet lengths, please contact Verco Decking, Inc.

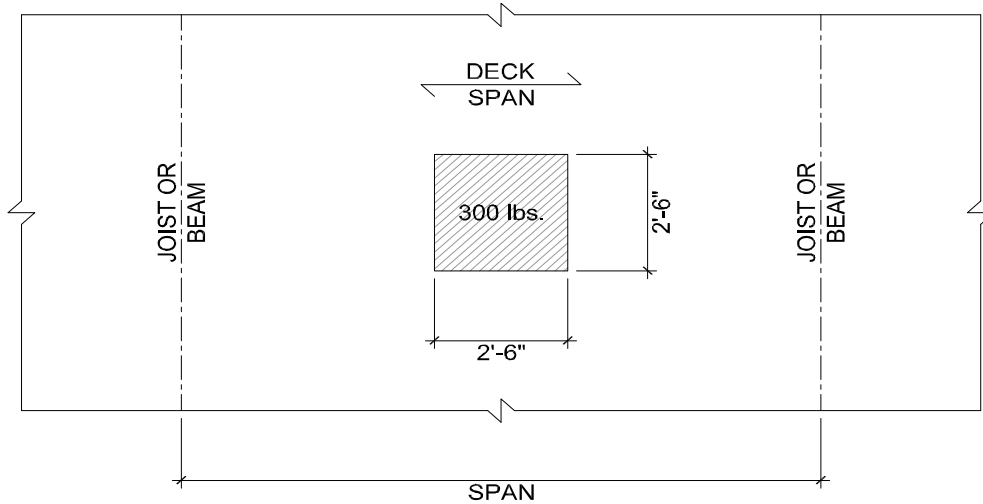

**Load Placement Bare Deck - Plan View**

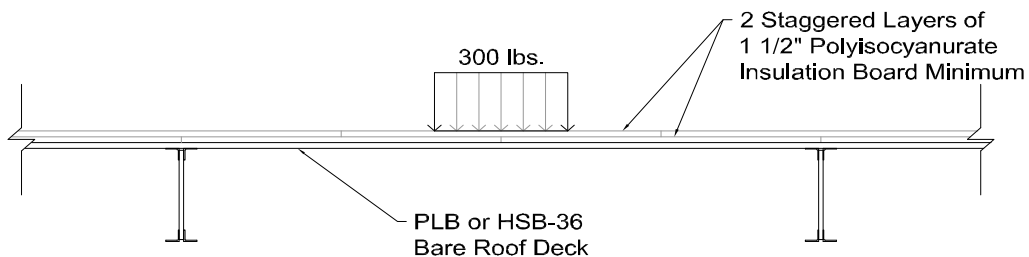

**Load Placement Bare Deck**

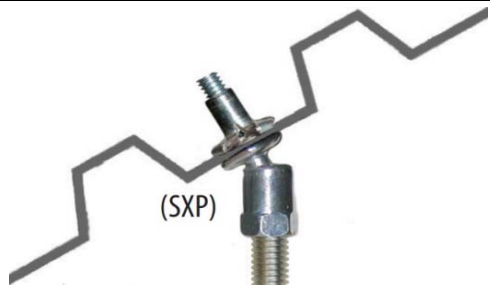

ITW BUILDEX SAMMYS X-PRESS SWIVEL HEAD® CONNECTION <sup>1-9</sup>					
Part Number	Model Number (Threaded Rod Size)	Deck Gage	Connection Strength (lbs)		Part Image
			ASD $P_{not}/\Omega$	LRFD $\phi P_{not}$	
8294922 8272957	SXP 20 (3/8") SXP 2.0 (1/2)	22	200	320	
		20	240	390	
		19	280	460	
		18	320	520	
8295922 8271957	SXP 35 (3/8") SXP 3.5 (1/2")	16	400	660	
14		500	820		

<sup>1</sup>  $P_{not}$  = Nominal pullout strength of SAMMYS X-Press Swivel Head® Connector

<sup>2</sup> Sammy X-press may be installed in any flat portion of the bottom flange, web or top flange as shown in figure below.

<sup>3</sup> Deck may be web perforated or fully perforated FP11 (11% open area).

<sup>4</sup> SAMMYS X-Press Swivel Head® shall not be installed in fully perforated FP21 (21% open area)

<sup>5</sup> The load may be applied at any angle,  $\theta$ , from 0 to 90 degrees,  $0 \leq \theta \leq 90$ , relative to the axis of the base of the Sammy X-press as shown below.

<sup>6</sup> The load may be applied at any angle,  $\alpha$ , from 0 to 360 degrees,  $0 \leq \alpha \leq 360$ , relative to the ribs of the steel deck as shown below.

<sup>7</sup> The allowable strength,  $P_n/\Omega$ , shall be equal to or greater than the governing nominal load or load combination for Allowable Stress Design (ASD) as stipulated in the IBC or ASCE/SEI 7.

<sup>8</sup> The factored strength,  $\phi P_n$ , shall be equal to or greater than the governing factored load or factored load combination for Load and Resistance Factor Design as stipulated in the IBC or ASCE/SEI 7.

<sup>9</sup> Safety and resistance factors included in the table are ASD:  $\Omega = 2.5$  and LRFD  $\phi = 0.65$  respectively.

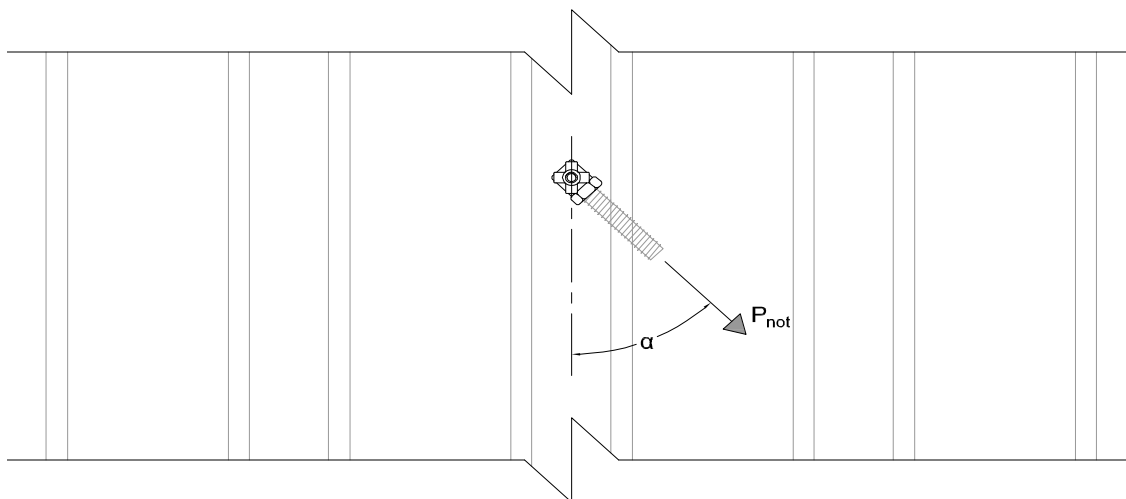
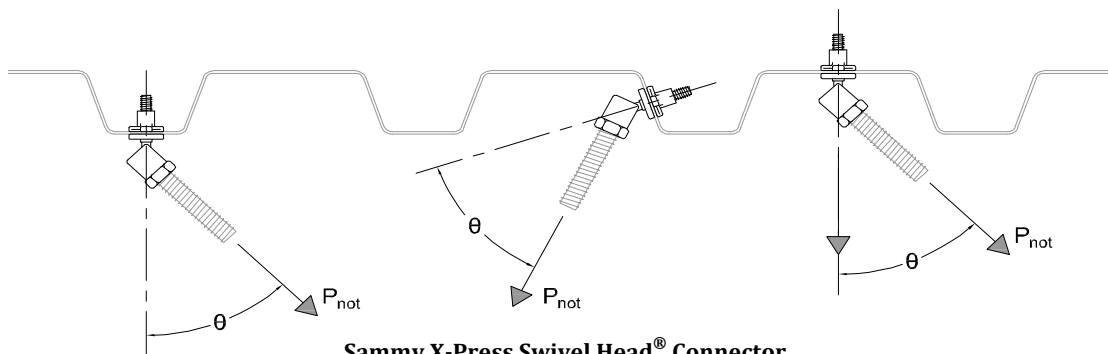



## DEFINITION OF SYMBOLS

Symbol	Definition	Units
$A_g$	Gross area of cross-section	in <sup>2</sup> /ft
$A_{gbf}$	Gross area of bottom flange	in <sup>2</sup>
$A_{gtf}$	Gross area of top flange	in <sup>2</sup>
$A_n$	Net area of cross-section, $A_n=A_g$ for non-perforated profiles	in <sup>2</sup> /ft
$A_{sbf}$	Cross-sectional area of bottom flange stiffener	in <sup>2</sup>
$A_{stf}$	Cross-sectional area of top flange stiffener	in <sup>2</sup>
$b_{obf}$	Overall flat width of stiffened bottom flange	in.
$b_{otf}$	Overall flat width of stiffened top flange	in.
$b_{pbf}$	Largest sub-element flat of stiffened bottom flange	in.
$b_{ptf}$	Largest sub-element flat of stiffened top flange	in.
$c_p$	Center-to-center spacing of perforation holes	in.
$c_{sbf}$	Horizontal distance from edge of bottom flange to centerline of bottom flange stiffener	in.
$c_{stf}$	Horizontal distance from edge of top flange to centerline of top flange stiffener	in.
$d_p$	Diameter of perforation hole	in.
$E_p$	Width of perforated band in bottom flange	in.
$F_p$	Width of perforated band in top flange	in.
$F_u$	Tensile strength of steel	ksi
$F_y$	Yield strength of steel	ksi
$h_w$	Flat dimension of web measured in plane of web	in.
$I_{d+}$	Positive moment of inertia for deflection due to vertical uniform loads, $I_{d+}=(2I_{e+}+I_x)/3$	in <sup>4</sup> /ft
$I_{d-}$	Negative moment of inertia for deflection due to vertical uniform loads, $I_{d-}=(2I_{e-}+I_x)/3$	in <sup>4</sup> /ft
$I_{e+}$	Positive effective moment of inertia	in <sup>4</sup> /ft
$I_{e-}$	Negative effective moment of inertia	in <sup>4</sup> /ft
$I_{spbf}$	Moment of inertia of stiffener about centerline of flat portion of bottom flange	in <sup>4</sup>
$I_{sptf}$	Moment of inertia of stiffener about centerline of flat portion of top flange	in <sup>4</sup>
$I_{xg}$	Moment of inertia of gross section (considering perforations for acoustic panels)	in <sup>4</sup> /ft
$K$	Composite deck-slab coefficient	-
$M_{n+}$	Nominal positive flexural strength of deck or panel, $M_{n+}=F_y \cdot S_{e+}$	k-ft/ft
$M_{n-}$	Nominal negative flexural strength of deck or panel, $M_{n-}=F_y \cdot S_{e-}$	k-ft/ft
$M_{nxt+}$	Nominal positive flexural strength with respect to centroidal axes considering tension yielding, $M_{nxt+}=F_y \cdot S_{ft+}$	k-ft/ft
$M_{nxt-}$	Nominal negative flexural strength with respect to centroidal axes considering tension yielding, $M_{nxt-}=F_y \cdot S_{ft-}$	k-ft/ft
$P_p$	Width of perforated band in bottom pan of cellular deck	in.
$R$	Inside bend radius	in.
$r$	Radius of gyration of gross section, $r=(I_{xg}/A_g)^{0.5}$	in.



### DEFINITION OF SYMBOLS (Continued)

Symbol	Definition	Units
$S_{bp}$	Spacing of resistance spot welds fastening panel to bottom pan for cellular deck	in.
$S_{e+}$	Positive effective section modulus	$\text{in}^3/\text{ft}$
$S_{e-}$	Negative effective section modulus	$\text{in}^3/\text{ft}$
$S_{ft+}$	Positive section modulus of gross section, $S_{ft+}=I_{xg}/y_b$	$\text{in}^3/\text{ft}$
$S_{ft-}$	Negative section modulus of gross section, $S_{ft-}=I_{xg}/y_t$	$\text{in}^3/\text{ft}$
$T_n$	Nominal tensile axial strength of panel, $T_n=F_y \cdot A_n$	k/ft
$t$	Base steel thickness of panel	in.
$t_b$	Base steel thickness of bottom element in cellular deck	in.
$V_n$	Nominal vertical web shear strength of panel	k/ft
$V_{ni}$	Nominal vertical shear capacity based on resistance weld strength (inverted deck orientation)	k/ft
$V_{nn}$	Nominal vertical shear capacity based on resistance weld strength (normal deck orientation)	k/ft
$W_p$	Width of perforated band in web	in.
$w_{bf}$	Flat width of bottom flange	in.
$w_{bp}$	Flat width of bottom pan between resistance welds	in.
$w_{dd}$	Weight of deck	psf
$w_{tf}$	Flat width of top flange	in.
$y_b$	Distance from extreme bottom fiber to neutral axis of gross section	in.
$y_t$	Distance from extreme top fiber to neutral axis of gross section	in.
$\theta$	Angle between plane of web and plane of bearing surface	deg.





Non-Embossed Profiles

PLB-36, HSB-36, HSB-36-SS

Embossed Profiles

PLB-36 FormLok,

B-36 FormLok,

B-36-SS FormLok

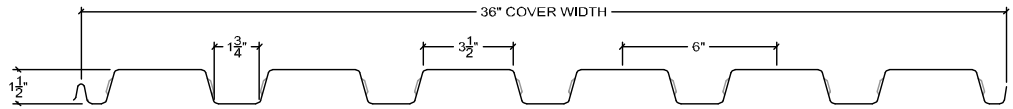

Gage	t in.	w <sub>dd</sub> psf	A <sub>g</sub> in <sup>2</sup> /ft	I <sub>xg</sub> in <sup>4</sup> /ft	S <sub>ft+</sub> in <sup>3</sup> /ft	S <sub>ft-</sub> in <sup>3</sup> /ft	y <sub>b</sub> in.	y <sub>t</sub> in.	r in.	h <sub>w</sub> in.	θ deg.	K <sub>min</sub> -
22	0.0299	1.9	0.506	0.193	0.211	0.313	0.913	0.617	0.618	1.240	75.1	1.000
20	0.0359	2.3	0.607	0.231	0.252	0.373	0.916	0.620	0.617	1.238	75.0	1.000
18	0.0478	2.9	0.807	0.306	0.332	0.490	0.923	0.625	0.616	1.233	74.7	1.000
16	0.0598	3.5	1.007	0.381	0.410	0.605	0.929	0.630	0.615	1.228	74.3	1.000

GRADE 50: F <sub>y</sub> = 50 ksi, F <sub>u</sub> = 65 ksi												
Gage	I <sub>e+</sub> in <sup>4</sup> /ft	I <sub>e-</sub> in <sup>4</sup> /ft	I <sub>d+</sub> in <sup>4</sup> /ft	I <sub>d-</sub> in <sup>4</sup> /ft	S <sub>e+</sub> in <sup>3</sup> /ft	S <sub>e-</sub> in <sup>3</sup> /ft	M <sub>n+</sub> k-ft/ft	M <sub>n-</sub> k-ft/ft	M <sub>nxt+</sub> k-ft/ft	M <sub>nxt-</sub> k-ft/ft	V <sub>n</sub> k/ft	T <sub>n</sub> k/ft
22	0.170	0.192	0.178	0.192	0.176	0.188	0.733	0.783	0.879	1.304	4.300	25.30
20	0.213	0.231	0.219	0.231	0.230	0.237	0.958	0.988	1.050	1.554	5.152	30.35
18	0.300	0.306	0.302	0.306	0.314	0.331	1.308	1.379	1.383	2.042	6.822	40.35
16	0.381	0.381	0.381	0.381	0.399	0.410	1.663	1.708	1.708	2.521	8.483	50.35

R	w <sub>tf</sub>	w <sub>bf</sub>
in.	in.	in.
0.188	3.125	1.375



Non-Embossed Profiles  
**HSBR-30-NS, HSBR-36,**  
**HSBR-36-SS**

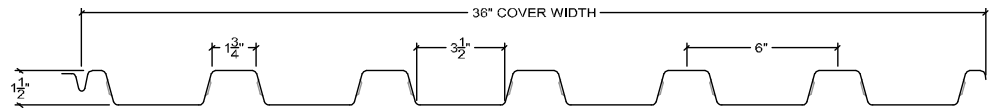

Embossed Profiles  
**BR-36 FormLok,**  
**BR-36-SS FormLok**

Gage	t in.	w <sub>dd</sub> psf	A <sub>g</sub> in <sup>2</sup> /ft	I <sub>xg</sub> in <sup>4</sup> /ft	S <sub>ft+</sub> in <sup>3</sup> /ft	S <sub>ft-</sub> in <sup>3</sup> /ft	y <sub>b</sub> in.	y <sub>t</sub> in.	r in.	h <sub>w</sub> in.	θ deg.	K <sub>min</sub> -
22	0.0299	1.9	0.506	0.193	0.313	0.211	0.617	0.913	0.618	1.240	75.1	1.000
20	0.0359	2.3	0.607	0.231	0.373	0.252	0.620	0.916	0.617	1.238	75.0	1.000
18	0.0478	2.9	0.807	0.306	0.490	0.332	0.625	0.923	0.616	1.233	74.7	1.000
16	0.0598	3.5	1.007	0.381	0.605	0.410	0.630	0.929	0.615	1.228	74.3	1.000

GRADE 50: F <sub>y</sub> = 50 ksi, F <sub>u</sub> = 65 ksi												
Gage	I <sub>e+</sub> in <sup>4</sup> /ft	I <sub>e-</sub> in <sup>4</sup> /ft	I <sub>d+</sub> in <sup>4</sup> /ft	I <sub>d-</sub> in <sup>4</sup> /ft	S <sub>e+</sub> in <sup>3</sup> /ft	S <sub>e-</sub> in <sup>3</sup> /ft	M <sub>n+</sub> k-ft/ft	M <sub>n-</sub> k-ft/ft	M <sub>nxt+</sub> k-ft/ft	M <sub>nxt-</sub> k-ft/ft	V <sub>n</sub> k/ft	T <sub>n</sub> k/ft
22	0.192	0.170	0.192	0.178	0.188	0.176	0.783	0.733	1.304	0.879	4.300	25.30
20	0.231	0.213	0.231	0.219	0.237	0.230	0.988	0.958	1.554	1.050	5.152	30.35
18	0.306	0.300	0.306	0.302	0.331	0.314	1.379	1.308	2.042	1.383	6.822	40.35
16	0.381	0.381	0.381	0.381	0.410	0.399	1.708	1.663	2.521	1.708	8.483	50.35

R	w <sub>tf</sub>	w <sub>bf</sub>
in.	in.	in.
0.188	1.375	3.125



Non-Embossed Profiles

PLN3-32, HSN3-32,  
HSN3-32-SS, HSN3-32-NS

Embossed Profiles

PLN3-32 FormLok,  
N3-32 FormLok,  
N3-32-SS FormLok,  
N3-32-NS FormLok

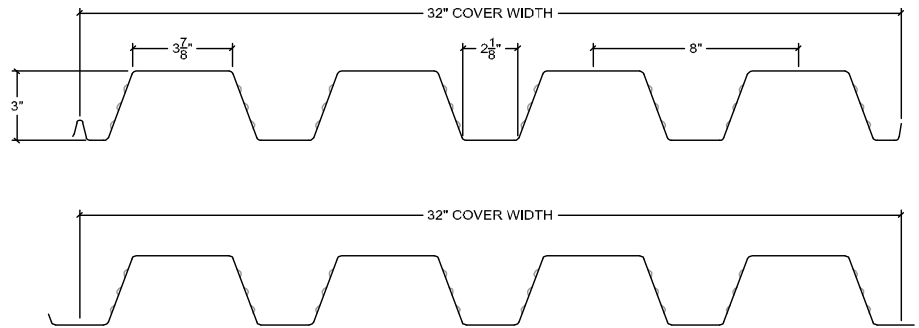

Gage	t in.	w <sub>dd</sub> psf	A <sub>g</sub> in <sup>2</sup> /ft	I <sub>xg</sub> in <sup>4</sup> /ft	S <sub>ft+</sub> in <sup>3</sup> /ft	S <sub>ft-</sub> in <sup>3</sup> /ft	y <sub>b</sub> in.	y <sub>t</sub> in.	r in.	h <sub>w</sub> in.	θ deg.	K <sub>min</sub> -
22	0.0299	2.0	0.567	0.800	0.474	0.596	1.687	1.343	1.188	2.879	71.2	1.000
20	0.0359	2.4	0.680	0.959	0.567	0.712	1.690	1.346	1.188	2.877	71.1	1.000
18	0.0478	3.1	0.905	1.273	0.750	0.942	1.697	1.351	1.186	2.872	71.0	1.000
16	0.0598	3.9	1.130	1.587	0.932	1.169	1.703	1.357	1.185	2.867	70.8	1.000

GRADE 50: F <sub>y</sub> = 50 ksi, F <sub>u</sub> = 65 ksi												
Gage	I <sub>e+</sub> in <sup>4</sup> /ft	I <sub>e-</sub> in <sup>4</sup> /ft	I <sub>d+</sub> in <sup>4</sup> /ft	I <sub>d-</sub> in <sup>4</sup> /ft	S <sub>e+</sub> in <sup>3</sup> /ft	S <sub>e-</sub> in <sup>3</sup> /ft	M <sub>n+</sub> k-ft/ft	M <sub>n-</sub> k-ft/ft	M <sub>nxt+</sub> k-ft/ft	M <sub>nxt-</sub> k-ft/ft	V <sub>n</sub> k/ft	T <sub>n</sub> k/ft
22	0.681	0.778	0.721	0.785	0.353	0.405	1.471	1.688	1.975	2.483	3.754	28.35
20	0.855	0.950	0.890	0.953	0.452	0.509	1.883	2.121	2.363	2.967	6.127	34.00
18	1.207	1.273	1.229	1.273	0.671	0.722	2.796	3.008	3.125	3.925	10.917	45.25
16	1.562	1.587	1.570	1.587	0.883	0.932	3.679	3.883	3.883	4.871	14.572	56.50

R	w <sub>tf</sub>	w <sub>bf</sub>
in.	in.	in.
0.188	3.523	1.773



Non-Embossed Profiles

PLN-24, N-24, N-24-SS

Embossed Profiles

PLN-24 FormLok,

N-24 FormLok,

N-24-SS FormLok

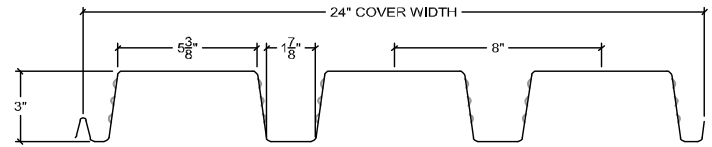

Gage	t in.	w <sub>dd</sub> psf	A <sub>g</sub> in <sup>2</sup> /ft	I <sub>xg</sub> in <sup>4</sup> /ft	S <sub>ft+</sub> in <sup>3</sup> /ft	S <sub>ft-</sub> in <sup>3</sup> /ft	y <sub>b</sub> in.	y <sub>t</sub> in.	r in.	h <sub>w</sub> in.	θ deg.	K <sub>min</sub> -
22	0.0299	2.2	0.617	0.862	0.466	0.730	1.849	1.181	1.182	2.672	82.4	1.000
20	0.0359	2.6	0.740	1.032	0.557	0.872	1.852	1.184	1.181	2.668	82.3	1.000
18	0.0478	3.5	0.983	1.369	0.736	1.152	1.860	1.188	1.180	2.661	82.1	1.000
16	0.0598	4.2	1.227	1.706	0.914	1.430	1.867	1.193	1.179	2.653	81.9	0.994

GRADE 50: F <sub>y</sub> = 50 ksi, F <sub>u</sub> = 65 ksi												
Gage	I <sub>e+</sub> in <sup>4</sup> /ft	I <sub>e-</sub> in <sup>4</sup> /ft	I <sub>d+</sub> in <sup>4</sup> /ft	I <sub>d-</sub> in <sup>4</sup> /ft	S <sub>e+</sub> in <sup>3</sup> /ft	S <sub>e-</sub> in <sup>3</sup> /ft	M <sub>n+</sub> k-ft/ft	M <sub>n-</sub> k-ft/ft	M <sub>nxt+</sub> k-ft/ft	M <sub>nxt-</sub> k-ft/ft	V <sub>n</sub> k/ft	T <sub>n</sub> k/ft
22	0.668	0.854	0.733	0.857	0.344	0.429	1.433	1.788	1.942	3.042	4.236	30.85
20	0.845	1.031	0.907	1.031	0.443	0.531	1.846	2.213	2.321	3.633	6.418	37.00
18	1.216	1.369	1.267	1.369	0.652	0.735	2.717	3.063	3.067	4.800	11.339	49.15
16	1.610	1.706	1.642	1.706	0.837	0.914	3.488	3.808	3.808	5.958	14.136	61.35

R in.	w <sub>tf</sub> in.	w <sub>bf</sub> in.
0.188	4.946	1.446



Embossed Profiles  
 PLW2-36 FormLok,  
 W2-36 FormLok,  
 W2-36-SS FormLok

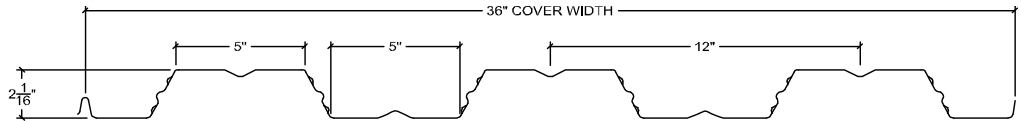

Gage	t in.	w <sub>dd</sub> psf	A <sub>g</sub> in <sup>2</sup> /ft	I <sub>xg</sub> in <sup>4</sup> /ft	S <sub>ft+</sub> in <sup>3</sup> /ft	S <sub>ft-</sub> in <sup>3</sup> /ft	y <sub>b</sub> in.	y <sub>t</sub> in.	r in.	h <sub>w</sub> in.	θ deg.	K <sub>min</sub> -
22	0.0300	1.8	0.464	0.362	0.353	0.339	1.026	1.067	0.883	2.049	63.7	1.000
21	0.0330	2.0	0.511	0.398	0.388	0.373	1.027	1.068	0.883	2.048	63.7	1.000
20	0.0360	2.1	0.557	0.434	0.422	0.406	1.029	1.070	0.883	2.047	63.6	1.000
19	0.0420	2.4	0.650	0.506	0.490	0.472	1.032	1.073	0.882	2.045	63.6	1.000
18	0.0470	2.7	0.727	0.565	0.546	0.526	1.035	1.075	0.882	2.044	63.5	1.000
16	0.0590	3.3	0.912	0.709	0.681	0.656	1.041	1.081	0.882	2.041	63.3	0.854

GRADE 50: F <sub>y</sub> = 50 ksi, F <sub>u</sub> = 65 ksi												
Gage	I <sub>e+</sub> in <sup>4</sup> /ft	I <sub>e-</sub> in <sup>4</sup> /ft	I <sub>d+</sub> in <sup>4</sup> /ft	I <sub>d-</sub> in <sup>4</sup> /ft	S <sub>e+</sub> in <sup>3</sup> /ft	S <sub>e-</sub> in <sup>3</sup> /ft	M <sub>n+</sub> k-ft/ft	M <sub>n-</sub> k-ft/ft	M <sub>nx+</sub> k-ft/ft	M <sub>nx-</sub> k-ft/ft	V <sub>n</sub> k/ft	T <sub>n</sub> k/ft
22	0.330	0.327	0.341	0.339	0.246	0.256	1.025	1.067	1.471	1.413	2.718	23.20
21	0.372	0.369	0.381	0.379	0.283	0.294	1.179	1.225	1.617	1.554	3.289	25.55
20	0.416	0.412	0.422	0.419	0.323	0.333	1.346	1.388	1.758	1.692	3.911	27.85
19	0.502	0.496	0.503	0.499	0.405	0.415	1.688	1.729	2.042	1.967	4.616	32.50
18	0.564	0.560	0.564	0.562	0.471	0.481	1.963	2.004	2.275	2.192	5.158	36.35
16	0.707	0.707	0.708	0.708	0.623	0.638	2.596	2.658	2.838	2.733	6.455	45.60

Gage	A <sub>gtf</sub> in <sup>2</sup>	A <sub>stf</sub> in <sup>2</sup>	I <sub>sptf</sub> in <sup>4</sup>	A <sub>gbf</sub> in <sup>2</sup>	A <sub>sbf</sub> in <sup>2</sup>	I <sub>spbf</sub> in <sup>4</sup>
22	0.148	0.036	0.001	0.148	0.036	0.001
21	0.163	0.040	0.001	0.163	0.040	0.001
20	0.177	0.043	0.001	0.177	0.043	0.001
19	0.206	0.050	0.002	0.206	0.050	0.002
18	0.231	0.056	0.002	0.231	0.056	0.002
16	0.289	0.071	0.002	0.289	0.071	0.002

b <sub>otf</sub> in.	b <sub>ptf</sub> in.	c <sub>stf</sub> in.	b <sub>obf</sub> in.	b <sub>pbf</sub> in.	c <sub>sbf</sub> in.
4.696	1.848	2.348	4.696	1.848	2.348

R in.	w <sub>tf</sub> in.	w <sub>bf</sub> in.
0.188	4.696	4.696



Embossed Profiles

PLW3-36 FormLok,  
W3-36 FormLok,  
W3-36-SS FormLok

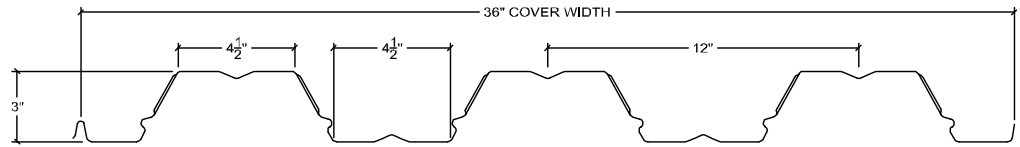

Gage	t in.	w <sub>dd</sub> psf	A <sub>g</sub> in <sup>2</sup> /ft	I <sub>xg</sub> in <sup>4</sup> /ft	S <sub>ft+</sub> in <sup>3</sup> /ft	S <sub>ft-</sub> in <sup>3</sup> /ft	y <sub>b</sub> in.	y <sub>t</sub> in.	r in.	h <sub>w</sub> in.	θ deg.	K <sub>min</sub> -
22	0.0299	1.9	0.497	0.761	0.515	0.490	1.478	1.552	1.237	3.113	63.2	0.000
21	0.0330	2.1	0.548	0.840	0.568	0.541	1.480	1.553	1.238	3.113	63.1	0.000
20	0.0359	2.3	0.596	0.914	0.617	0.588	1.481	1.555	1.238	3.112	63.1	0.000
19	0.0420	2.7	0.697	1.068	0.719	0.685	1.485	1.558	1.238	3.110	63.0	0.000
18	0.0478	2.9	0.793	1.214	0.816	0.778	1.488	1.560	1.237	3.108	63.0	0.000
16	0.0598	3.5	0.991	1.517	1.015	0.969	1.494	1.566	1.237	3.105	62.9	0.000

GRADE 50: F <sub>y</sub> = 50 ksi, F <sub>u</sub> = 65 ksi												
Gage	I <sub>e+</sub> in <sup>4</sup> /ft	I <sub>e-</sub> in <sup>4</sup> /ft	I <sub>d+</sub> in <sup>4</sup> /ft	I <sub>d-</sub> in <sup>4</sup> /ft	S <sub>e+</sub> in <sup>3</sup> /ft	S <sub>e-</sub> in <sup>3</sup> /ft	M <sub>n+</sub> k-ft/ft	M <sub>n-</sub> k-ft/ft	M <sub>nxt+</sub> k-ft/ft	M <sub>nxt-</sub> k-ft/ft	V <sub>n</sub> k/ft	T <sub>n</sub> k/ft
22	0.723	0.715	0.736	0.730	0.393	0.410	1.638	1.708	2.146	2.042	2.183	24.85
21	0.816	0.806	0.824	0.817	0.453	0.470	1.888	1.958	2.367	2.254	2.932	27.40
20	0.904	0.892	0.907	0.899	0.510	0.528	2.125	2.200	2.571	2.450	3.776	29.80
19	1.067	1.058	1.067	1.061	0.636	0.652	2.650	2.717	2.996	2.854	5.295	34.85
18	1.213	1.210	1.213	1.211	0.752	0.768	3.133	3.200	3.400	3.242	6.858	39.65
16	1.515	1.516	1.516	1.516	0.968	0.966	4.033	4.025	4.229	4.038	9.918	49.55

Gage	A <sub>gtf</sub> in <sup>2</sup>	A <sub>stf</sub> in <sup>2</sup>	I <sub>sptf</sub> in <sup>4</sup>	A <sub>gbf</sub> in <sup>2</sup>	A <sub>sbf</sub> in <sup>2</sup>	I <sub>spbf</sub> in <sup>4</sup>
22	0.132	0.036	0.001	0.132	0.036	0.001
21	0.146	0.040	0.001	0.146	0.040	0.001
20	0.159	0.043	0.001	0.159	0.043	0.001
19	0.186	0.050	0.002	0.186	0.050	0.002
18	0.211	0.057	0.002	0.211	0.057	0.002
16	0.263	0.072	0.002	0.263	0.072	0.002

b <sub>otf</sub> in.	b <sub>ptf</sub> in.	c <sub>stf</sub> in.	b <sub>obf</sub> in.	b <sub>pbf</sub> in.	c <sub>sbf</sub> in.
4.198	1.599	2.099	4.198	1.599	2.099

R in.	w <sub>tf</sub> in.	w <sub>bf</sub> in.
0.188	4.198	4.198





Non-Embossed Profiles

9/16 Shallow Vercor

9/16 Shallow Vercor Inverted

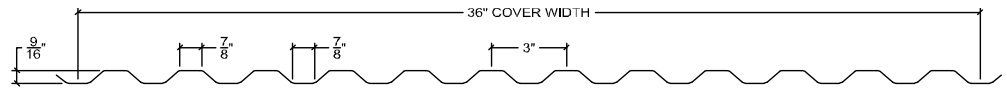

Gage	t in.	w <sub>dd</sub> psf	A <sub>g</sub> in <sup>2</sup> /ft	I <sub>xg</sub> in <sup>4</sup> /ft	S <sub>ft+</sub> in <sup>3</sup> /ft	S <sub>ft-</sub> in <sup>3</sup> /ft	y <sub>b</sub> in.	y <sub>t</sub> in.	r in.	h <sub>w</sub> in.	θ deg.
26	0.0179	1.0	0.256	0.013	0.046	0.044	0.283	0.298	0.225	0.696	41.7
24	0.0239	1.3	0.342	0.018	0.063	0.060	0.286	0.301	0.229	0.696	41.6
22	0.0299	1.6	0.428	0.022	0.076	0.072	0.289	0.304	0.227	0.696	41.5
20	0.0359	1.9	0.513	0.027	0.092	0.088	0.292	0.307	0.229	0.696	41.4

GRADE 80: F <sub>y</sub> = 60 ksi, F <sub>u</sub> = 62 ksi												
Gage	I <sub>e+</sub> in <sup>4</sup> /ft	I <sub>e-</sub> in <sup>4</sup> /ft	I <sub>d+</sub> in <sup>4</sup> /ft	I <sub>d-</sub> in <sup>4</sup> /ft	S <sub>e+</sub> in <sup>3</sup> /ft	S <sub>e-</sub> in <sup>3</sup> /ft	M <sub>n+</sub> k-ft/ft	M <sub>n-</sub> k-ft/ft	M <sub>nxt+</sub> k-ft/ft	M <sub>nxt-</sub> k-ft/ft	V <sub>n</sub> k/ft	T <sub>n</sub> k/ft
26	0.013	0.013	0.013	0.013	0.041	0.043	0.205	0.215	0.230	0.220	2.387	15.36
24	0.018	0.018	0.018	0.018	0.059	0.059	0.295	0.295	0.315	0.300	3.181	20.52
22	0.022	0.022	0.022	0.022	0.073	0.073	0.365	0.365	0.380	0.360	3.971	25.68
20	0.027	0.027	0.027	0.027	0.087	0.087	0.435	0.435	0.460	0.440	4.759	30.78

R in.	w <sub>tf</sub> in.	w <sub>bf</sub> in.
0.188	0.710	0.710



Non-Embossed Profiles

1-5/16 Deep Vercor

1-5/16 Deep Vercor Inverted

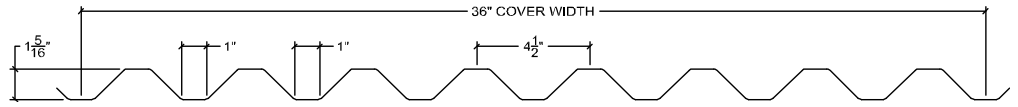

Gage	t in.	w <sub>dd</sub> psf	A <sub>g</sub> in <sup>2</sup> /ft	I <sub>xg</sub> in <sup>4</sup> /ft	S <sub>ft+</sub> in <sup>3</sup> /ft	S <sub>ft-</sub> in <sup>3</sup> /ft	y <sub>b</sub> in.	y <sub>t</sub> in.	r in.	h <sub>w</sub> in.	θ deg.
26	0.0195	1.1	0.304	0.075	0.117	0.109	0.640	0.690	0.497	1.650	46.2
24	0.0254	1.4	0.396	0.097	0.151	0.140	0.643	0.693	0.495	1.649	46.2
22	0.0314	1.7	0.490	0.120	0.185	0.172	0.647	0.696	0.495	1.649	46.1
20	0.0374	2.1	0.583	0.143	0.220	0.205	0.650	0.699	0.495	1.648	46.0

GRADE 80: F <sub>y</sub> = 60 ksi, F <sub>u</sub> = 62 ksi												
Gage	I <sub>e+</sub> in <sup>4</sup> /ft	I <sub>e-</sub> in <sup>4</sup> /ft	I <sub>d+</sub> in <sup>4</sup> /ft	I <sub>d-</sub> in <sup>4</sup> /ft	S <sub>e+</sub> in <sup>3</sup> /ft	S <sub>e-</sub> in <sup>3</sup> /ft	M <sub>n+</sub> k-ft/ft	M <sub>n-</sub> k-ft/ft	M <sub>nxt+</sub> k-ft/ft	M <sub>nxt-</sub> k-ft/ft	V <sub>n</sub> k/ft	T <sub>n</sub> k/ft
26	0.073	0.073	0.074	0.074	0.099	0.103	0.495	0.515	0.585	0.545	2.463	18.24
24	0.097	0.096	0.097	0.096	0.137	0.138	0.685	0.690	0.755	0.700	4.582	23.76
22	0.120	0.120	0.120	0.120	0.172	0.171	0.860	0.855	0.925	0.860	6.991	29.40
20	0.143	0.143	0.143	0.143	0.204	0.204	1.020	1.020	1.100	1.025	8.513	34.98

R	w <sub>tf</sub>	w <sub>bf</sub>
in.	in.	in.
0.188	0.810	0.810



Web Perforated Profiles  
 PLB-36 AC, HSB-36 AC,  
 HSB-36-SS AC

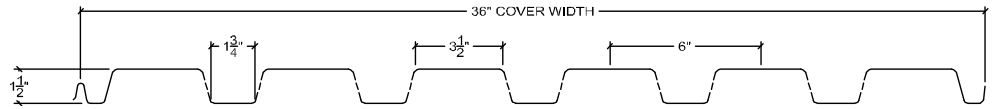

Gage	t in.	w <sub>dd</sub> psf	A <sub>g</sub> in <sup>2</sup> /ft	A <sub>n</sub> in <sup>2</sup> /ft	I <sub>xg</sub> in <sup>4</sup> /ft	S <sub>ft+</sub> in <sup>3</sup> /ft	S <sub>ft-</sub> in <sup>3</sup> /ft	y <sub>b</sub> in.	y <sub>t</sub> in.	r in.	h <sub>w</sub> in.	θ deg.
22	0.0299	1.9	0.506	0.493	0.187	0.205	0.303	0.913	0.617	0.616	1.240	75.1
20	0.0359	2.3	0.607	0.591	0.224	0.245	0.361	0.916	0.620	0.616	1.238	75.0
18	0.0478	2.9	0.807	0.786	0.297	0.322	0.475	0.923	0.625	0.615	1.233	74.7
16	0.0598	3.5	1.007	0.981	0.370	0.398	0.587	0.929	0.630	0.614	1.228	74.3

GRADE 50: F <sub>y</sub> = 50 ksi, F <sub>u</sub> = 65 ksi												
Gage	I <sub>e+</sub> in <sup>4</sup> /ft	I <sub>e-</sub> in <sup>4</sup> /ft	I <sub>d+</sub> in <sup>4</sup> /ft	I <sub>d-</sub> in <sup>4</sup> /ft	S <sub>e+</sub> in <sup>3</sup> /ft	S <sub>e-</sub> in <sup>3</sup> /ft	M <sub>n+</sub> k-ft/ft	M <sub>n-</sub> k-ft/ft	M <sub>nxt+</sub> k-ft/ft	M <sub>nxt-</sub> k-ft/ft	V <sub>n</sub> k/ft	T <sub>n</sub> k/ft
22	0.166	0.187	0.173	0.187	0.170	0.182	0.708	0.758	0.854	1.263	3.574	24.65
20	0.208	0.225	0.213	0.225	0.223	0.230	0.929	0.958	1.021	1.504	4.281	29.55
18	0.293	0.299	0.294	0.298	0.306	0.322	1.275	1.342	1.342	1.979	5.664	39.30
16	0.372	0.372	0.371	0.371	0.388	0.399	1.617	1.663	1.658	2.446	7.038	49.05

R	w <sub>tf</sub>	w <sub>bf</sub>
in.	in.	in.
0.188	3.125	1.375

d <sub>p</sub>	c <sub>p</sub>	W <sub>p</sub>
in.	in.	in.
0.156	0.433	0.806



Web Perforated Profiles

PLN3-32 AC, HSN3-32 AC,  
HSN3-32-SS AC,  
HSN3-32-NS AC

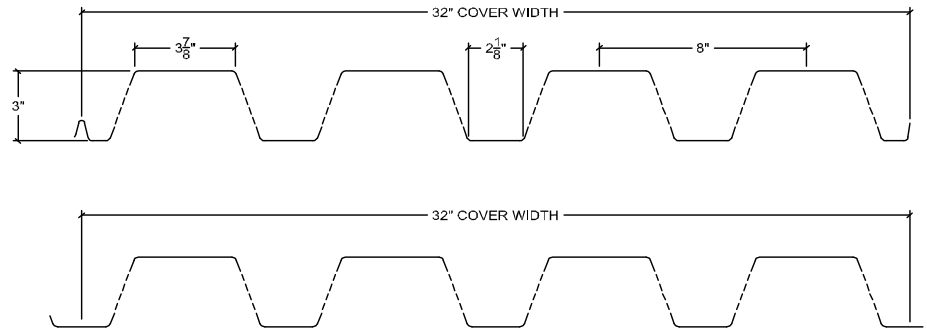

Gage	t in.	w <sub>dd</sub> psf	A <sub>g</sub> in <sup>2</sup> /ft	A <sub>n</sub> in <sup>2</sup> /ft	I <sub>xg</sub> in <sup>4</sup> /ft	S <sub>ft+</sub> in <sup>3</sup> /ft	S <sub>ft-</sub> in <sup>3</sup> /ft	y <sub>b</sub> in.	y <sub>t</sub> in.	r in.	h <sub>w</sub> in.	θ deg.
22	0.0299	2.0	0.567	0.538	0.752	0.446	0.560	1.687	1.343	1.182	2.879	71.2
20	0.0359	2.4	0.680	0.645	0.901	0.533	0.669	1.690	1.346	1.182	2.877	71.1
18	0.0478	3.1	0.905	0.858	1.197	0.705	0.886	1.697	1.351	1.181	2.872	71.0
16	0.0598	3.9	1.130	1.072	1.492	0.876	1.099	1.703	1.357	1.180	2.867	70.8

GRADE 50: F <sub>y</sub> = 50 ksi, F <sub>u</sub> = 65 ksi												
Gage	I <sub>e+</sub> in <sup>4</sup> /ft	I <sub>e-</sub> in <sup>4</sup> /ft	I <sub>d+</sub> in <sup>4</sup> /ft	I <sub>d-</sub> in <sup>4</sup> /ft	S <sub>e+</sub> in <sup>3</sup> /ft	S <sub>e-</sub> in <sup>3</sup> /ft	M <sub>n+</sub> k-ft/ft	M <sub>n-</sub> k-ft/ft	M <sub>nxt+</sub> k-ft/ft	M <sub>nxt-</sub> k-ft/ft	V <sub>n</sub> k/ft	T <sub>n</sub> k/ft
22	0.635	0.729	0.674	0.737	0.321	0.374	1.338	1.558	1.858	2.333	3.042	26.90
20	0.799	0.891	0.833	0.894	0.414	0.471	1.725	1.963	2.221	2.788	4.992	32.25
18	1.132	1.194	1.154	1.195	0.620	0.672	2.583	2.800	2.938	3.692	8.841	42.90
16	1.467	1.490	1.475	1.491	0.821	0.870	3.421	3.625	3.650	4.579	11.796	53.60

R	w <sub>tf</sub>	w <sub>bf</sub>
in.	in.	in.
0.188	3.523	1.773

d <sub>p</sub>	c <sub>p</sub>	W <sub>p</sub>
in.	in.	in.
0.156	0.433	2.105



Web Perforated Profiles

PLN-24 AC, N-24 AC,  
N-24-SS AC

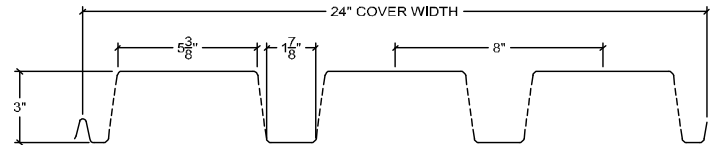

Gage	t in.	w <sub>dd</sub> psf	A <sub>g</sub> in <sup>2</sup> /ft	A <sub>n</sub> in <sup>2</sup> /ft	I <sub>xg</sub> in <sup>4</sup> /ft	S <sub>ft+</sub> in <sup>3</sup> /ft	S <sub>ft-</sub> in <sup>3</sup> /ft	y <sub>b</sub> in.	y <sub>t</sub> in.	r in.	h <sub>w</sub> in.	θ deg.
22	0.0299	2.2	0.617	0.590	0.819	0.443	0.693	1.849	1.181	1.178	2.672	82.4
20	0.0359	2.6	0.740	0.708	0.980	0.529	0.828	1.852	1.184	1.177	2.668	82.3
18	0.0478	3.5	0.983	0.941	1.301	0.699	1.095	1.860	1.188	1.176	2.661	82.1
16	0.0598	4.2	1.227	1.175	1.621	0.868	1.359	1.867	1.193	1.175	2.653	81.9

GRADE 50: F <sub>y</sub> = 50 ksi, F <sub>u</sub> = 65 ksi												
Gage	I <sub>e+</sub> in <sup>4</sup> /ft	I <sub>e-</sub> in <sup>4</sup> /ft	I <sub>d+</sub> in <sup>4</sup> /ft	I <sub>d-</sub> in <sup>4</sup> /ft	S <sub>e+</sub> in <sup>3</sup> /ft	S <sub>e-</sub> in <sup>3</sup> /ft	M <sub>n+</sub> k-ft/ft	M <sub>n-</sub> k-ft/ft	M <sub>nxt+</sub> k-ft/ft	M <sub>nxt-</sub> k-ft/ft	V <sub>n</sub> k/ft	T <sub>n</sub> k/ft
22	0.629	0.810	0.692	0.813	0.317	0.403	1.321	1.679	1.846	2.888	3.459	29.50
20	0.799	0.978	0.859	0.979	0.411	0.498	1.713	2.075	2.204	3.450	5.269	35.40
18	1.153	1.299	1.202	1.300	0.609	0.692	2.538	2.883	2.913	4.563	9.252	47.05
16	1.529	1.619	1.560	1.620	0.784	0.860	3.267	3.583	3.617	5.663	11.526	58.75

R	w <sub>tf</sub>	w <sub>bf</sub>
in.	in.	in.
0.188	4.946	1.446

d <sub>p</sub>	c <sub>p</sub>	W <sub>p</sub>
in.	in.	in.
0.156	0.433	1.888



Fully Perforated Profiles

(11% Open Area)

PLB-36 FP11, HSB-36 FP11,  
HSB-36-SS FP11

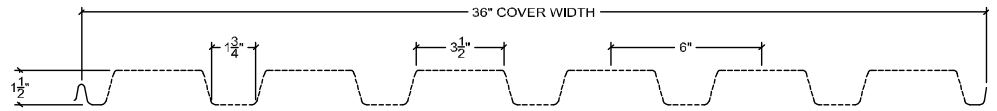

Gage	t in.	w <sub>dd</sub> psf	A <sub>g</sub> in <sup>2</sup> /ft	A <sub>n</sub> in <sup>2</sup> /ft	I <sub>xg</sub> in <sup>4</sup> /ft	S <sub>ft+</sub> in <sup>3</sup> /ft	S <sub>ft-</sub> in <sup>3</sup> /ft	y <sub>b</sub> in.	y <sub>t</sub> in.	r in.	h <sub>w</sub> in.	θ deg.
22	0.0299	1.7	0.506	0.447	0.170	0.186	0.276	0.913	0.617	0.617	1.240	75.1
20	0.0359	2.0	0.607	0.536	0.204	0.223	0.329	0.916	0.620	0.617	1.238	75.0
18	0.0478	2.6	0.807	0.712	0.270	0.293	0.432	0.923	0.625	0.616	1.233	74.7
16	0.0598	3.1	1.007	0.889	0.336	0.362	0.533	0.929	0.630	0.615	1.228	74.3

GRADE 50: F <sub>y</sub> = 50 ksi, F <sub>u</sub> = 65 ksi												
Gage	I <sub>e+</sub> in <sup>4</sup> /ft	I <sub>e-</sub> in <sup>4</sup> /ft	I <sub>d+</sub> in <sup>4</sup> /ft	I <sub>d-</sub> in <sup>4</sup> /ft	S <sub>e+</sub> in <sup>3</sup> /ft	S <sub>e-</sub> in <sup>3</sup> /ft	M <sub>n+</sub> k-ft/ft	M <sub>n-</sub> k-ft/ft	M <sub>nxt+</sub> k-ft/ft	M <sub>nxt-</sub> k-ft/ft	V <sub>n</sub> k/ft	T <sub>n</sub> k/ft
22	0.127	0.133	0.141	0.145	0.098	0.105	0.408	0.438	0.775	1.150	3.185	22.35
20	0.157	0.160	0.173	0.175	0.128	0.132	0.533	0.550	0.929	1.371	3.816	26.80
18	0.211	0.211	0.231	0.231	0.175	0.185	0.729	0.771	1.221	1.800	5.053	35.60
16	0.263	0.263	0.287	0.287	0.223	0.229	0.929	0.954	1.508	2.221	6.283	44.45

R	w <sub>tf</sub>	w <sub>bf</sub>
in.	in.	in.
0.188	3.125	1.375

d <sub>p</sub>	c <sub>p</sub>
in.	in.
0.156	0.433





Fully Perforated Profiles

(11% Open Area)

PLN3-32 FP11, HSN3-32 FP11,  
HSN3-32-SS FP11

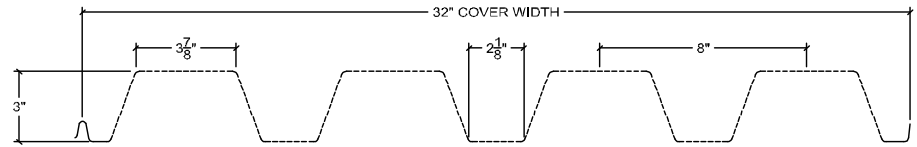

Gage	t in.	w <sub>dd</sub> psf	A <sub>g</sub> in <sup>2</sup> /ft	A <sub>n</sub> in <sup>2</sup> /ft	I <sub>xg</sub> in <sup>4</sup> /ft	S <sub>ft+</sub> in <sup>3</sup> /ft	S <sub>ft-</sub> in <sup>3</sup> /ft	y <sub>b</sub> in.	y <sub>t</sub> in.	r in.	h <sub>w</sub> in.	θ deg.
22	0.0299	1.8	0.567	0.501	0.706	0.418	0.526	1.687	1.343	1.187	2.879	71.2
20	0.0359	2.1	0.680	0.601	0.847	0.501	0.629	1.690	1.346	1.187	2.877	71.1
18	0.0478	2.8	0.905	0.799	1.124	0.662	0.832	1.697	1.351	1.186	2.872	71.0
16	0.0598	3.5	1.130	0.998	1.401	0.823	1.032	1.703	1.357	1.185	2.867	70.8

GRADE 50: F <sub>y</sub> = 50 ksi, F <sub>u</sub> = 65 ksi												
Gage	I <sub>e+</sub> in <sup>4</sup> /ft	I <sub>e-</sub> in <sup>4</sup> /ft	I <sub>d+</sub> in <sup>4</sup> /ft	I <sub>d-</sub> in <sup>4</sup> /ft	S <sub>e+</sub> in <sup>3</sup> /ft	S <sub>e-</sub> in <sup>3</sup> /ft	M <sub>n+</sub> k-ft/ft	M <sub>n-</sub> k-ft/ft	M <sub>nxt+</sub> k-ft/ft	M <sub>nxt-</sub> k-ft/ft	V <sub>n</sub> k/ft	T <sub>n</sub> k/ft
22	0.512	0.552	0.577	0.603	0.197	0.226	0.821	0.942	1.742	2.192	2.781	25.05
20	0.636	0.663	0.706	0.724	0.252	0.284	1.050	1.183	2.088	2.621	4.564	30.05
18	0.875	0.880	0.958	0.961	0.374	0.403	1.558	1.679	2.758	3.467	8.086	39.95
16	1.098	1.098	1.199	1.199	0.493	0.520	2.054	2.167	3.429	4.300	10.793	49.90

R	w <sub>tf</sub>	w <sub>bf</sub>
in.	in.	in.
0.188	3.523	1.773

d <sub>p</sub>	c <sub>p</sub>
in.	in.
0.156	0.433



Fully Perforated Profiles  
 (11% Open Area)  
 PLN-24 FP11, N-24 FP11,  
 N-24-SS FP11

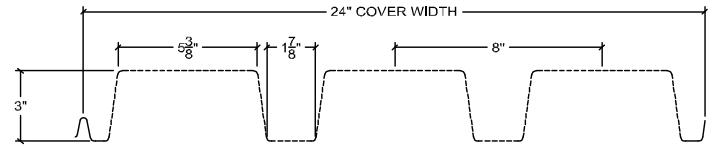

Gage	t in.	w <sub>dd</sub> psf	A <sub>g</sub> in <sup>2</sup> /ft	A <sub>n</sub> in <sup>2</sup> /ft	I <sub>xg</sub> in <sup>4</sup> /ft	S <sub>ft+</sub> in <sup>3</sup> /ft	S <sub>ft-</sub> in <sup>3</sup> /ft	y <sub>b</sub> in.	y <sub>t</sub> in.	r in.	h <sub>w</sub> in.	θ deg.
22	0.0299	2.0	0.617	0.545	0.761	0.412	0.644	1.849	1.181	1.182	2.672	82.4
20	0.0359	2.3	0.740	0.653	0.911	0.492	0.769	1.852	1.184	1.181	2.668	82.3
18	0.0478	3.1	0.983	0.868	1.209	0.650	1.018	1.860	1.188	1.180	2.661	82.1
16	0.0598	3.7	1.227	1.084	1.506	0.807	1.262	1.867	1.193	1.179	2.653	81.9

GRADE 50: F <sub>y</sub> = 50 ksi, F <sub>u</sub> = 65 ksi												
Gage	I <sub>e+</sub> in <sup>4</sup> /ft	I <sub>e-</sub> in <sup>4</sup> /ft	I <sub>d+</sub> in <sup>4</sup> /ft	I <sub>d-</sub> in <sup>4</sup> /ft	S <sub>e+</sub> in <sup>3</sup> /ft	S <sub>e-</sub> in <sup>3</sup> /ft	M <sub>n+</sub> k-ft/ft	M <sub>n-</sub> k-ft/ft	M <sub>nxt+</sub> k-ft/ft	M <sub>nxt-</sub> k-ft/ft	V <sub>n</sub> k/ft	T <sub>n</sub> k/ft
22	0.513	0.596	0.596	0.651	0.192	0.240	0.800	1.000	1.717	2.683	3.137	27.25
20	0.645	0.714	0.734	0.780	0.247	0.296	1.029	1.233	2.050	3.204	4.780	32.65
18	0.910	0.947	1.010	1.034	0.364	0.410	1.517	1.708	2.708	4.242	8.399	43.40
16	1.172	1.180	1.283	1.289	0.467	0.510	1.946	2.125	3.363	5.258	10.470	54.20

R	w <sub>tf</sub>	w <sub>bf</sub>
in.	in.	in.
0.188	4.946	1.446

d <sub>p</sub>	c <sub>p</sub>
in.	in.
0.156	0.433



Fully Perforated Profiles

(21% Open Area)

PLB-36 FP21, HSB-36 FP21,

HSB-36-SS FP21,

HSB-30-NS FP21

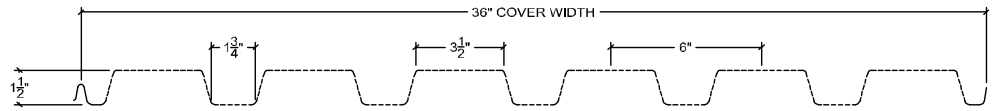

Gage	t in.	w <sub>dd</sub> psf	A <sub>g</sub> in <sup>2</sup> /ft	A <sub>n</sub> in <sup>2</sup> /ft	I <sub>xg</sub> in <sup>4</sup> /ft	S <sub>ft+</sub> in <sup>3</sup> /ft	S <sub>ft-</sub> in <sup>3</sup> /ft	y <sub>b</sub> in.	y <sub>t</sub> in.	r in.	h <sub>w</sub> in.	θ deg.
22	0.0299	1.5	0.506	0.396	0.151	0.165	0.245	0.913	0.617	0.618	1.240	75.1
20	0.0359	1.8	0.607	0.475	0.181	0.198	0.292	0.916	0.620	0.617	1.238	75.0
18	0.0478	2.3	0.807	0.631	0.239	0.259	0.382	0.923	0.625	0.615	1.233	74.7
16	0.0598	2.8	1.007	0.787	0.298	0.321	0.473	0.929	0.630	0.615	1.228	74.3

GRADE 50: F <sub>y</sub> = 50 ksi, F <sub>u</sub> = 65 ksi												
Gage	I <sub>e+</sub> in <sup>4</sup> /ft	I <sub>e-</sub> in <sup>4</sup> /ft	I <sub>d+</sub> in <sup>4</sup> /ft	I <sub>d-</sub> in <sup>4</sup> /ft	S <sub>e+</sub> in <sup>3</sup> /ft	S <sub>e-</sub> in <sup>3</sup> /ft	M <sub>n+</sub> k-ft/ft	M <sub>n-</sub> k-ft/ft	M <sub>nxt+</sub> k-ft/ft	M <sub>nxt-</sub> k-ft/ft	V <sub>n</sub> k/ft	T <sub>n</sub> k/ft
22	0.102	0.104	0.118	0.120	0.078	0.083	0.325	0.346	0.688	1.021	2.364	19.80
20	0.124	0.124	0.143	0.143	0.102	0.105	0.425	0.438	0.825	1.217	2.833	23.75
18	0.165	0.165	0.190	0.190	0.139	0.147	0.579	0.613	1.079	1.592	3.751	31.55
16	0.205	0.205	0.236	0.236	0.177	0.182	0.738	0.758	1.338	1.971	4.665	39.35

R	w <sub>tf</sub>	w <sub>bf</sub>
in.	in.	in.
0.188	3.125	1.375

d <sub>p</sub>	c <sub>p</sub>
in.	in.
0.156	0.326



Fully Perforated Profiles

(21% Open Area)

PLN3-32 FP21, HSN3-32 FP21,  
HSN3-32-SS FP21

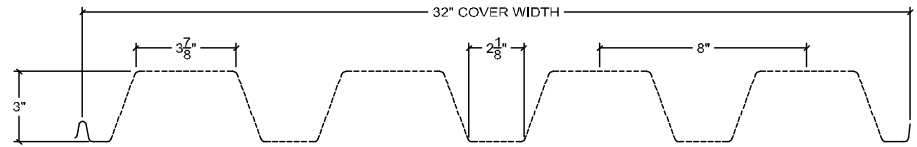

Gage	t in.	w <sub>dd</sub> psf	A <sub>g</sub> in <sup>2</sup> /ft	A <sub>n</sub> in <sup>2</sup> /ft	I <sub>xg</sub> in <sup>4</sup> /ft	S <sub>ft+</sub> in <sup>3</sup> /ft	S <sub>ft-</sub> in <sup>3</sup> /ft	y <sub>b</sub> in.	y <sub>t</sub> in.	r in.	h <sub>w</sub> in.	θ deg.
22	0.0299	1.6	0.567	0.443	0.626	0.371	0.466	1.687	1.343	1.189	2.879	71.2
20	0.0359	1.9	0.680	0.532	0.750	0.444	0.557	1.690	1.346	1.187	2.877	71.1
18	0.0478	2.4	0.905	0.707	0.995	0.586	0.736	1.697	1.351	1.186	2.872	71.0
16	0.0598	3.1	1.130	0.884	1.241	0.729	0.915	1.703	1.357	1.185	2.867	70.8

GRADE 50: F <sub>y</sub> = 50 ksi, F <sub>u</sub> = 65 ksi												
Gage	I <sub>e+</sub> in <sup>4</sup> /ft	I <sub>e-</sub> in <sup>4</sup> /ft	I <sub>d+</sub> in <sup>4</sup> /ft	I <sub>d-</sub> in <sup>4</sup> /ft	S <sub>e+</sub> in <sup>3</sup> /ft	S <sub>e-</sub> in <sup>3</sup> /ft	M <sub>n+</sub> k-ft/ft	M <sub>n-</sub> k-ft/ft	M <sub>nxt+</sub> k-ft/ft	M <sub>nxt-</sub> k-ft/ft	V <sub>n</sub> k/ft	T <sub>n</sub> k/ft
22	0.411	0.431	0.483	0.496	0.156	0.180	0.650	0.750	1.546	1.942	2.064	22.15
20	0.507	0.517	0.588	0.595	0.200	0.225	0.833	0.938	1.850	2.321	3.388	26.60
18	0.686	0.686	0.789	0.789	0.297	0.320	1.238	1.333	2.442	3.067	6.003	35.35
16	0.856	0.856	0.984	0.984	0.391	0.413	1.629	1.721	3.038	3.813	8.012	44.20

R	w <sub>tf</sub>	w <sub>bf</sub>
in.	in.	in.
0.188	3.523	1.773

d <sub>p</sub>	c <sub>p</sub>
in.	in.
0.156	0.326



Fully Perforated Profiles  
 (21% Open Area)  
 PLN-24 FP21, N-24 FP21,  
 N-24-SS FP21

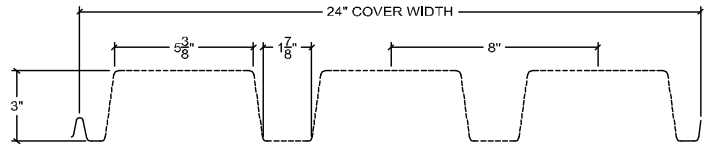

Gage	t in.	w <sub>dd</sub> psf	A <sub>g</sub> in <sup>2</sup> /ft	A <sub>n</sub> in <sup>2</sup> /ft	I <sub>xg</sub> in <sup>4</sup> /ft	S <sub>ft+</sub> in <sup>3</sup> /ft	S <sub>ft-</sub> in <sup>3</sup> /ft	y <sub>b</sub> in.	y <sub>t</sub> in.	r in.	h <sub>w</sub> in.	θ deg.
22	0.0299	1.7	0.617	0.482	0.674	0.365	0.571	1.849	1.181	1.183	2.672	82.4
20	0.0359	2.1	0.740	0.578	0.807	0.436	0.682	1.852	1.184	1.182	2.668	82.3
18	0.0478	2.8	0.983	0.769	1.071	0.576	0.902	1.860	1.188	1.180	2.661	82.1
16	0.0598	3.3	1.227	0.960	1.334	0.715	1.118	1.867	1.193	1.179	2.653	81.9

GRADE 50: F <sub>y</sub> = 50 ksi, F <sub>u</sub> = 65 ksi												
Gage	I <sub>e+</sub> in <sup>4</sup> /ft	I <sub>e-</sub> in <sup>4</sup> /ft	I <sub>d+</sub> in <sup>4</sup> /ft	I <sub>d-</sub> in <sup>4</sup> /ft	S <sub>e+</sub> in <sup>3</sup> /ft	S <sub>e-</sub> in <sup>3</sup> /ft	M <sub>n+</sub> k-ft/ft	M <sub>n-</sub> k-ft/ft	M <sub>nxt+</sub> k-ft/ft	M <sub>nxt-</sub> k-ft/ft	V <sub>n</sub> k/ft	T <sub>n</sub> k/ft
22	0.415	0.465	0.501	0.535	0.152	0.190	0.633	0.792	1.521	2.379	2.329	24.10
20	0.520	0.557	0.616	0.640	0.196	0.235	0.817	0.979	1.817	2.842	3.549	28.90
18	0.725	0.738	0.840	0.849	0.289	0.326	1.204	1.358	2.400	3.758	6.235	38.45
16	0.920	0.920	1.058	1.058	0.371	0.405	1.546	1.688	2.979	4.658	7.773	48.00

R	w <sub>tf</sub>	w <sub>bf</sub>
in.	in.	in.
0.188	4.946	1.446

d <sub>p</sub>	c <sub>p</sub>
in.	in.
0.156	0.326



Non-Embossed Profiles

PLBCD-36, HSBCD-36

Embossed Profiles

PLBCD-36 FormLok,

BCD-36 FormLok

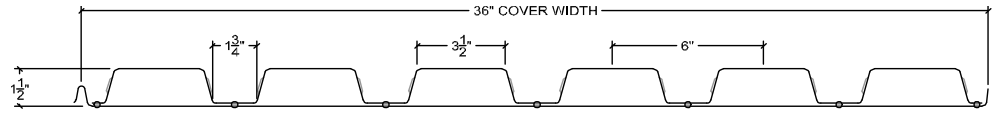

Gage	t in.	t <sub>b</sub> in.	w <sub>dd</sub> psf	A <sub>g</sub> in <sup>2</sup> /ft	I <sub>xg</sub> in <sup>4</sup> /ft	S <sub>ft+</sub> in <sup>3</sup> /ft	S <sub>ft-</sub> in <sup>3</sup> /ft	y <sub>b</sub> in.	y <sub>t</sub> in.	r in.	h <sub>w</sub> in.	θ deg.	K <sub>min</sub> -
20/20	0.0359	0.0359	3.6	1.028	0.448	0.785	0.448	0.571	1.001	0.660	1.238	75.0	1.000
20/18	0.0359	0.0478	4.1	1.179	0.490	0.953	0.458	0.514	1.070	0.645	1.238	75.0	1.000
18/20	0.0478	0.0359	4.1	1.216	0.550	0.861	0.582	0.639	0.945	0.673	1.233	74.7	1.000
18/18	0.0478	0.0478	4.6	1.367	0.603	1.034	0.596	0.583	1.012	0.664	1.233	74.7	1.000
18/16	0.0478	0.0598	5.1	1.520	0.649	1.202	0.608	0.540	1.068	0.653	1.233	74.7	1.000
16/18	0.0598	0.0478	5.3	1.556	0.708	1.110	0.730	0.638	0.970	0.675	1.228	74.3	1.000
16/16	0.0598	0.0598	5.8	1.709	0.763	1.280	0.745	0.596	1.024	0.668	1.228	74.3	1.000

Gage	GRADE 50: F <sub>y</sub> = 50 ksi, F <sub>u</sub> = 65 ksi													
	I <sub>e+</sub> in <sup>4</sup> /ft	I <sub>e-</sub> in <sup>4</sup> /ft	I <sub>d+</sub> in <sup>4</sup> /ft	I <sub>d-</sub> in <sup>4</sup> /ft	S <sub>e+</sub> in <sup>3</sup> /ft	S <sub>e-</sub> in <sup>3</sup> /ft	M <sub>n+</sub> k-ft/ft	M <sub>n-</sub> k-ft/ft	M <sub>nx+</sub> k-ft/ft	M <sub>nx-</sub> k-ft/ft	V <sub>n</sub> k/ft	T <sub>n</sub> k/ft	V <sub>nn</sub> k/ft	V <sub>ni</sub> k/ft
20/20	0.400	0.280	0.416	0.336	0.279	0.382	1.163	1.592	3.271	1.867	5.152	51.40	0.799	1.200
20/18	0.436	0.318	0.454	0.375	0.287	0.428	1.196	1.783	3.971	1.908	5.152	58.95	0.748	0.868
18/20	0.528	0.354	0.535	0.419	0.417	0.453	1.738	1.888	3.588	2.425	6.822	60.80	0.866	1.439
18/18	0.579	0.391	0.587	0.462	0.428	0.552	1.783	2.300	4.308	2.483	6.822	68.35	1.215	1.567
18/16	0.622	0.443	0.631	0.512	0.437	0.575	1.821	2.396	5.008	2.533	6.822	76.00	1.154	1.231
16/18	0.702	0.467	0.704	0.547	0.587	0.629	2.446	2.621	4.625	3.042	8.483	77.80	1.291	1.779
16/16	0.757	0.517	0.759	0.599	0.599	0.700	2.496	2.917	5.333	3.104	8.483	85.45	1.686	1.928

R in.	w <sub>tf</sub> in.	w <sub>bf</sub> in.	w <sub>bp1</sub> in.	S <sub>bp</sub> in.
0.188	3.125	1.375	6.000	6.000



Non-Embossed Profiles

PLN3CD-32, HSN3CD-32

Embossed Profiles

PLN3CD-32 FormLok,

N3CD-32 FormLok

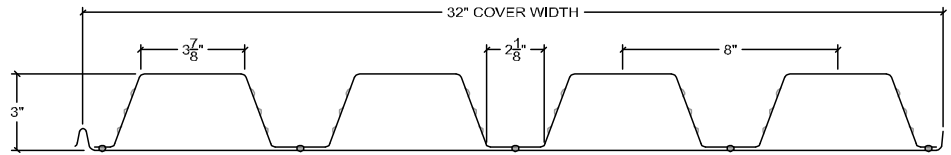

Gage	t in.	t <sub>b</sub> in.	w <sub>dd</sub> psf	A <sub>g</sub> in <sup>2</sup> /ft	I <sub>xg</sub> in <sup>4</sup> /ft	S <sub>ft+</sub> in <sup>3</sup> /ft	S <sub>ft-</sub> in <sup>3</sup> /ft	y <sub>b</sub> in.	y <sub>t</sub> in.	r in.	h <sub>w</sub> in.	θ deg.	K <sub>min</sub> -
20/20	0.0359	0.0359	3.9	1.099	1.714	1.593	0.859	1.076	1.996	1.249	2.877	71.1	1.000
20/18	0.0359	0.0478	4.4	1.251	1.863	1.937	0.878	0.962	2.122	1.220	2.877	71.1	1.000
18/20	0.0478	0.0359	4.6	1.310	2.105	1.757	1.116	1.198	1.886	1.268	2.872	71.0	1.000
18/18	0.0478	0.0478	5.1	1.463	2.294	2.107	1.143	1.089	2.007	1.252	2.872	71.0	1.000
18/16	0.0478	0.0598	5.7	1.616	2.452	2.450	1.164	1.001	2.107	1.232	2.872	71.0	1.000
16/18	0.0598	0.0478	5.9	1.675	2.694	2.272	1.402	1.186	1.922	1.268	2.867	70.8	1.000
16/16	0.0598	0.0598	6.4	1.828	2.884	2.617	1.429	1.102	2.018	1.256	2.867	70.8	1.000

GRADE 50: F <sub>y</sub> = 50 ksi, F <sub>u</sub> = 65 ksi														
Gage	I <sub>e+</sub> in <sup>4</sup> /ft	I <sub>e-</sub> in <sup>4</sup> /ft	I <sub>d+</sub> in <sup>4</sup> /ft	I <sub>d-</sub> in <sup>4</sup> /ft	S <sub>e+</sub> in <sup>3</sup> /ft	S <sub>e-</sub> in <sup>3</sup> /ft	M <sub>n+</sub> k-ft/ft	M <sub>n-</sub> k-ft/ft	M <sub>nx+</sub> k-ft/ft	M <sub>nx-</sub> k-ft/ft	V <sub>n</sub> k/ft	T <sub>n</sub> k/ft	V <sub>nn</sub> k/ft	V <sub>ni</sub> k/ft
20/20	1.511	1.172	1.579	1.353	0.505	0.709	2.104	2.954	6.638	3.579	6.127	54.95	1.241	2.786
20/18	1.643	1.394	1.716	1.550	0.503	0.801	2.096	3.338	8.071	3.658	6.127	62.55	1.149	1.755
18/20	1.973	1.474	2.017	1.684	0.804	0.869	3.350	3.621	7.321	4.650	10.917	65.50	1.361	3.379
18/18	2.144	1.699	2.194	1.897	0.824	1.030	3.433	4.292	8.779	4.763	10.917	73.15	1.887	3.351
18/16	2.293	1.997	2.346	2.149	0.829	1.077	3.454	4.488	10.208	4.850	10.917	80.80	1.776	2.599
16/18	2.631	2.007	2.652	2.236	1.107	1.210	4.613	5.042	9.467	5.842	14.572	83.75	2.025	3.958
16/16	2.815	2.316	2.838	2.505	1.129	1.314	4.704	5.475	10.904	5.954	14.572	91.40	2.620	4.076

R	w <sub>tf</sub>	w <sub>bf</sub>	w <sub>bp1</sub>	S <sub>bp</sub>
in.	in.	in.	in.	in.
0.188	3.523	1.773	8.000	6.000



Non-Embossed Profiles

PLNCD-24, NCD-24

Embossed Profiles

PLNCD-24 FormLok,

NCD-24 FormLok

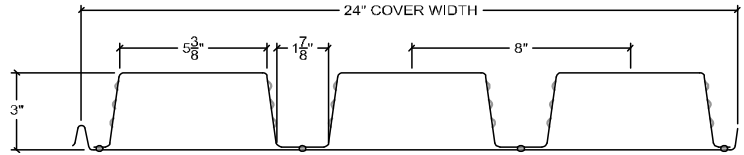

Gage	t in.	t <sub>b</sub> in.	w <sub>dd</sub> psf	A <sub>g</sub> in <sup>2</sup> /ft	I <sub>xg</sub> in <sup>4</sup> /ft	S <sub>ft+</sub> in <sup>3</sup> /ft	S <sub>ft-</sub> in <sup>3</sup> /ft	y <sub>b</sub> in.	y <sub>t</sub> in.	r in.	h <sub>w</sub> in.	θ deg.	K <sub>min</sub> -
20/20	0.0359	0.0359	4.1	1.152	1.961	1.611	1.057	1.217	1.855	1.305	2.668	82.3	1.000
20/18	0.0359	0.0478	4.6	1.308	2.154	1.976	1.080	1.090	1.994	1.283	2.668	82.3	1.000
18/20	0.0478	0.0359	4.8	1.376	2.381	1.762	1.374	1.351	1.733	1.315	2.661	82.1	1.000
18/18	0.0478	0.0478	5.3	1.532	2.624	2.133	1.406	1.230	1.866	1.309	2.661	82.1	1.000
18/16	0.0478	0.0598	5.8	1.689	2.829	2.499	1.432	1.132	1.976	1.294	2.661	82.1	1.000
16/18	0.0598	0.0478	6.1	1.757	3.054	2.286	1.724	1.336	1.771	1.318	2.653	81.9	0.994
16/16	0.0598	0.0598	6.6	1.914	3.299	2.654	1.758	1.243	1.877	1.313	2.653	81.9	0.994

GRADE 50: F <sub>y</sub> = 50 ksi, F <sub>u</sub> = 65 ksi														
Gage	I <sub>e+</sub> in <sup>4</sup> /ft	I <sub>e-</sub> in <sup>4</sup> /ft	I <sub>d+</sub> in <sup>4</sup> /ft	I <sub>d-</sub> in <sup>4</sup> /ft	S <sub>e+</sub> in <sup>3</sup> /ft	S <sub>e-</sub> in <sup>3</sup> /ft	M <sub>n+</sub> k-ft/ft	M <sub>n-</sub> k-ft/ft	M <sub>next+</sub> k-ft/ft	M <sub>next-</sub> k-ft/ft	V <sub>n</sub> k/ft	T <sub>n</sub> k/ft	V <sub>nn</sub> k/ft	V <sub>ni</sub> k/ft
20/20	1.541	1.211	1.681	1.461	0.518	0.706	2.158	2.942	6.713	4.404	6.418	57.60	1.313	2.441
20/18	1.685	1.356	1.841	1.622	0.515	0.909	2.146	3.788	8.233	4.500	6.418	65.40	1.226	1.688
18/20	2.048	1.519	2.159	1.806	0.805	0.852	3.354	3.550	7.342	5.725	11.339	68.80	1.428	2.943
18/18	2.241	1.679	2.369	1.994	0.826	1.055	3.442	4.396	8.888	5.858	11.339	76.60	1.998	2.996
18/16	2.402	1.845	2.544	2.173	0.843	1.318	3.513	5.492	10.413	5.967	11.339	84.45	1.892	2.271
16/18	2.795	1.994	2.881	2.347	1.121	1.199	4.671	4.996	9.525	7.183	14.136	87.85	2.128	3.420
16/16	3.009	2.174	3.106	2.549	1.144	1.475	4.767	6.146	11.058	7.325	14.136	95.70	2.774	3.521

R	w <sub>tf</sub>	w <sub>bf</sub>	w <sub>bp1</sub>	S <sub>bp</sub>
in.	in.	in.	in.	in.
0.188	4.946	1.446	8.000	6.000





Embossed Profiles  
 PLW2CD-36 FormLok,  
 W2CD-36 FormLok

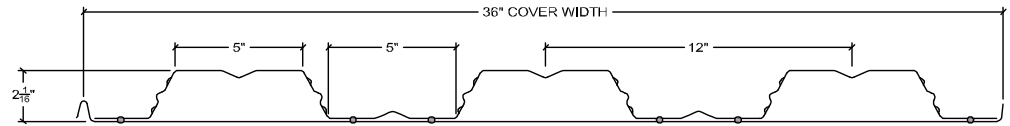

Gage	t in.	t <sub>b</sub> in.	w <sub>dd</sub> psf	A <sub>g</sub> in <sup>2</sup> /ft	I <sub>xg</sub> in <sup>4</sup> /ft	S <sub>ft+</sub> in <sup>3</sup> /ft	S <sub>ft-</sub> in <sup>3</sup> /ft	y <sub>b</sub> in.	y <sub>t</sub> in.	r in.	h <sub>w</sub> in.	θ deg.	K <sub>min</sub> -
20/20	0.0360	0.0359	3.4	0.957	0.690	1.099	0.458	0.628	1.506	0.849	2.047	63.6	1.000
20/18	0.0360	0.0478	3.8	1.108	0.740	1.326	0.466	0.558	1.588	0.817	2.047	63.6	1.000
18/20	0.0470	0.0359	3.9	1.109	0.848	1.206	0.588	0.703	1.442	0.874	2.044	63.5	1.000
18/18	0.0470	0.0478	4.3	1.261	0.912	1.438	0.599	0.634	1.523	0.850	2.044	63.5	1.000
18/16	0.0470	0.0598	4.8	1.413	0.965	1.661	0.608	0.581	1.588	0.826	2.044	63.5	1.000
16/18	0.0590	0.0478	4.9	1.427	1.088	1.554	0.741	0.700	1.469	0.873	2.041	63.3	0.854
16/16	0.0590	0.0598	5.4	1.580	1.154	1.784	0.752	0.647	1.534	0.855	2.041	63.3	0.854

GRADE 50: F <sub>y</sub> = 50 ksi, F <sub>u</sub> = 65 ksi														
Gage	I <sub>e+</sub> in <sup>4</sup> /ft	I <sub>e-</sub> in <sup>4</sup> /ft	I <sub>d+</sub> in <sup>4</sup> /ft	I <sub>d-</sub> in <sup>4</sup> /ft	S <sub>e+</sub> in <sup>3</sup> /ft	S <sub>e-</sub> in <sup>3</sup> /ft	M <sub>n+</sub> k-ft/ft	M <sub>n-</sub> k-ft/ft	M <sub>nx+</sub> k-ft/ft	M <sub>nx-</sub> k-ft/ft	V <sub>n</sub> k/ft	T <sub>n</sub> k/ft	V <sub>nn</sub> k/ft	V <sub>ni</sub> k/ft
20/20	0.655	0.497	0.667	0.561	0.363	0.429	1.513	1.788	4.579	1.908	3.911	47.85	0.949	1.443
20/18	0.700	0.552	0.713	0.615	0.372	0.446	1.550	1.858	5.525	1.942	3.911	55.40	0.885	1.019
18/20	0.847	0.619	0.847	0.695	0.526	0.549	2.192	2.288	5.025	2.450	5.158	55.45	1.032	1.774
18/18	0.911	0.678	0.911	0.756	0.536	0.570	2.233	2.375	5.992	2.496	5.158	63.05	1.400	1.741
18/16	0.964	0.792	0.964	0.850	0.544	0.586	2.267	2.442	6.921	2.533	5.158	70.65	1.320	1.519
16/18	1.087	0.813	1.087	0.905	0.704	0.702	2.933	2.925	6.475	3.088	6.455	71.35	1.499	2.036
16/16	1.152	0.883	1.153	0.973	0.714	0.722	2.975	3.008	7.433	3.133	6.455	79.00	1.953	2.231

Gage	A <sub>gtf</sub> in <sup>2</sup>	A <sub>stf</sub> in <sup>2</sup>	I <sub>sptf</sub> in <sup>4</sup>	A <sub>gbf</sub> in <sup>2</sup>	A <sub>sbf</sub> in <sup>2</sup>	I <sub>spbf</sub> in <sup>4</sup>
20/xx	0.177	0.043	0.001	0.177	0.043	0.001
18/xx	0.231	0.056	0.002	0.231	0.056	0.002
16/xx	0.289	0.071	0.002	0.289	0.071	0.002

b <sub>otf</sub> in.	b <sub>ptf</sub> in.	c <sub>stf</sub> in.	b <sub>obf</sub> in.	b <sub>pbf</sub> in.	c <sub>sbf</sub> in.
4.696	1.848	2.348	4.696	1.848	2.348

R in.	w <sub>bp1</sub> in.	w <sub>bp2</sub> in.	s <sub>bp</sub> in.
0.188	9.250	2.750	6.000



Embossed Profiles  
 PLW3CD-36 FormLok,  
 W3CD-36 FormLok

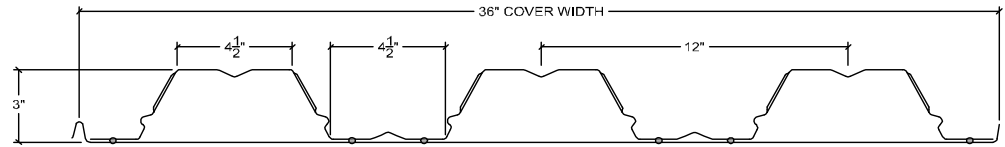

Gage	t in.	t <sub>b</sub> in.	w <sub>dd</sub> psf	A <sub>g</sub> in <sup>2</sup> /ft	I <sub>xg</sub> in <sup>4</sup> /ft	S <sub>ft+</sub> in <sup>3</sup> /ft	S <sub>ft-</sub> in <sup>3</sup> /ft	y <sub>b</sub> in.	y <sub>t</sub> in.	r in.	h <sub>w</sub> in.	θ deg.	K <sub>min</sub> -
20/20	0.0359	0.0359	3.6	1.002	1.456	1.598	0.674	0.911	2.161	1.205	3.112	63.1	0.000
20/18	0.0359	0.0478	4.0	1.153	1.562	1.936	0.686	0.807	2.277	1.164	3.112	63.1	0.000
18/20	0.0478	0.0359	4.1	1.182	1.814	1.771	0.881	1.024	2.060	1.239	3.108	63.0	0.000
18/18	0.0478	0.0478	4.6	1.334	1.950	2.113	0.897	0.923	2.173	1.209	3.108	63.0	0.000
18/16	0.0478	0.0598	5.0	1.486	2.063	2.447	0.911	0.843	2.264	1.178	3.108	63.0	0.000
16/18	0.0598	0.0478	5.2	1.515	2.317	2.287	1.106	1.013	2.095	1.237	3.105	62.9	0.000
16/16	0.0598	0.0598	5.7	1.668	2.454	2.625	1.124	0.935	2.184	1.213	3.105	62.9	0.000

GRADE 50: F <sub>y</sub> = 50 ksi, F <sub>u</sub> = 65 ksi														
Gage	I <sub>e+</sub> in <sup>4</sup> /ft	I <sub>e-</sub> in <sup>4</sup> /ft	I <sub>d+</sub> in <sup>4</sup> /ft	I <sub>d-</sub> in <sup>4</sup> /ft	S <sub>e+</sub> in <sup>3</sup> /ft	S <sub>e-</sub> in <sup>3</sup> /ft	M <sub>n+</sub> k-ft/ft	M <sub>n-</sub> k-ft/ft	M <sub>nx+</sub> k-ft/ft	M <sub>nx-</sub> k-ft/ft	V <sub>n</sub> k/ft	T <sub>n</sub> k/ft	V <sub>nn</sub> k/ft	V <sub>ni</sub> k/ft
20/20	1.455	1.050	1.455	1.185	0.542	0.625	2.258	2.604	6.658	2.808	3.776	50.10	1.342	2.142
20/18	1.550	1.163	1.554	1.296	0.541	0.652	2.254	2.717	8.067	2.858	3.776	57.65	1.240	1.449
18/20	1.813	1.331	1.813	1.492	0.852	0.813	3.550	3.388	7.379	3.671	6.858	59.10	1.477	2.753
18/18	1.949	1.452	1.949	1.618	0.862	0.846	3.592	3.525	8.804	3.738	6.858	66.70	2.042	2.689
18/16	2.061	1.688	2.062	1.813	0.859	0.874	3.579	3.642	10.196	3.796	6.858	74.30	1.917	2.246
16/18	2.315	1.738	2.316	1.931	1.105	1.037	4.604	4.321	9.529	4.608	9.918	75.75	2.195	3.183
16/16	2.452	1.882	2.453	2.073	1.123	1.073	4.679	4.471	10.938	4.683	9.918	83.40	2.834	3.304

Gage	A <sub>gtf</sub> in <sup>2</sup>	A <sub>stf</sub> in <sup>2</sup>	I <sub>sptf</sub> in <sup>4</sup>	A <sub>gbf</sub> in <sup>2</sup>	A <sub>sbf</sub> in <sup>2</sup>	I <sub>spbf</sub> in <sup>4</sup>
20/xx	0.159	0.043	0.001	0.159	0.043	0.001
18/xx	0.211	0.057	0.002	0.211	0.057	0.002
16/xx	0.263	0.072	0.002	0.263	0.072	0.002

b <sub>otf</sub> in.	b <sub>ptf</sub> in.	c <sub>stf</sub> in.	b <sub>obf</sub> in.	b <sub>pbf</sub> in.	c <sub>sbf</sub> in.
4.198	1.599	2.099	4.198	1.599	2.099

R in.	w <sub>bp1</sub> in.	w <sub>bp2</sub> in.	s <sub>bp</sub> in.
0.188	9.250	2.750	6.000



# EVALUATION REPORT

Number:

2018

Originally Issued: 07/11/2019

Valid Through: 07/31/2020

Page 43 of 47

Non-Embossed Profiles

PLBCD-36 AC, HSBCD-36 AC

Embossed Profiles

PLBCD-36 AC FormLok,

BCD-36 AC FormLok

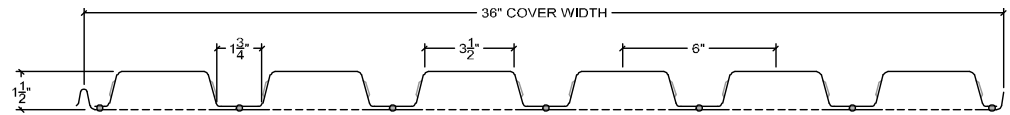

Gage	t in.	t <sub>b</sub> in.	w <sub>dd</sub> psf	A <sub>g</sub> in <sup>2</sup> /ft	A <sub>n</sub> in <sup>2</sup> /ft	I <sub>xg</sub> in <sup>4</sup> /ft	S <sub>ft+</sub> in <sup>3</sup> /ft	S <sub>ft-</sub> in <sup>3</sup> /ft	y <sub>b</sub> in.	y <sub>t</sub> in.	r in.	h <sub>w</sub> in.	θ deg.	K <sub>min</sub> -
20/20	0.0359	0.0359	3.6	1.028	0.988	0.435	0.734	0.444	0.593	0.979	0.664	1.238	75.0	1.000
20/18	0.0359	0.0478	4.1	1.179	1.127	0.477	0.888	0.456	0.537	1.047	0.651	1.238	75.0	1.000
18/20	0.0478	0.0359	4.1	1.216	1.176	0.534	0.809	0.578	0.660	0.924	0.674	1.233	74.7	1.000
18/18	0.0478	0.0478	4.6	1.367	1.314	0.586	0.967	0.592	0.606	0.990	0.668	1.233	74.7	1.000
18/16	0.0478	0.0598	5.1	1.520	1.454	0.631	1.121	0.604	0.563	1.045	0.659	1.233	74.7	1.000
16/18	0.0598	0.0478	5.3	1.556	1.503	0.687	1.041	0.725	0.660	0.948	0.676	1.228	74.3	1.000
16/16	0.0598	0.0598	5.8	1.709	1.642	0.741	1.197	0.740	0.619	1.001	0.672	1.228	74.3	1.000

GRADE 50: F <sub>y</sub> = 50 ksi, F <sub>u</sub> = 65 ksi														
Gage	I <sub>e+</sub> in <sup>4</sup> /ft	I <sub>e-</sub> in <sup>4</sup> /ft	I <sub>d+</sub> in <sup>4</sup> /ft	I <sub>d-</sub> in <sup>4</sup> /ft	S <sub>e+</sub> in <sup>3</sup> /ft	S <sub>e-</sub> in <sup>3</sup> /ft	M <sub>n+</sub> k-ft/ft	M <sub>n-</sub> k-ft/ft	M <sub>nx+</sub> k-ft/ft	M <sub>nx-</sub> k-ft/ft	V <sub>n</sub> k/ft	T <sub>n</sub> k/ft	V <sub>nn</sub> k/ft	V <sub>ni</sub> k/ft
20/20	0.390	0.330	0.405	0.365	0.277	0.382	1.154	1.592	3.058	1.850	5.152	49.40	0.820	1.415
20/18	0.425	0.394	0.442	0.422	0.285	0.428	1.188	1.783	3.700	1.900	5.152	56.35	0.764	1.076
18/20	0.513	0.408	0.520	0.450	0.414	0.453	1.725	1.888	3.371	2.408	6.822	58.80	0.894	1.656
18/18	0.562	0.473	0.570	0.511	0.425	0.552	1.771	2.300	4.029	2.467	6.822	65.70	1.247	1.894
18/16	0.605	0.552	0.614	0.578	0.434	0.575	1.808	2.396	4.671	2.517	6.822	72.70	1.179	1.535
16/18	0.682	0.554	0.684	0.598	0.583	0.629	2.429	2.621	4.338	3.021	8.483	75.15	1.331	2.111
16/16	0.735	0.635	0.737	0.670	0.595	0.700	2.479	2.917	4.988	3.083	8.483	82.10	1.730	2.368

R	w <sub>tf</sub>	w <sub>bf</sub>	w <sub>bp1</sub>	S <sub>bp</sub>
in.	in.	in.	in.	in.
0.188	3.125	1.375	6.000	6.000

d <sub>p</sub>	c <sub>p</sub>	P <sub>p</sub>
in.	in.	in.
0.156	0.433	3.620



Non-Embossed Profiles

PLN3CD-32 AC, HSN3CD-32 AC

Embossed Profiles

PLN3CD-32 AC FormLok,

N3CD-32 AC FormLok

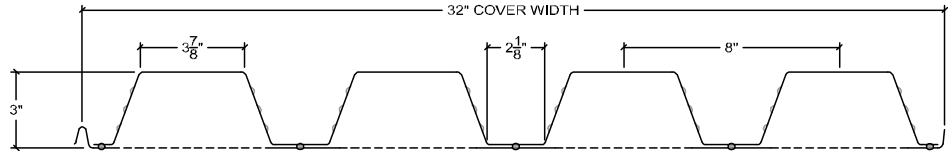

Gage	t in.	t <sub>b</sub> in.	w <sub>dd</sub> psf	A <sub>g</sub> in <sup>2</sup> /ft	A <sub>n</sub> in <sup>2</sup> /ft	I <sub>xg</sub> in <sup>4</sup> /ft	S <sub>ft+</sub> in <sup>3</sup> /ft	S <sub>ft-</sub> in <sup>3</sup> /ft	y <sub>b</sub> in.	y <sub>t</sub> in.	r in.	h <sub>w</sub> in.	θ deg.	K <sub>min</sub> -
20/20	0.0359	0.0359	3.9	1.099	1.054	1.661	1.480	0.852	1.122	1.950	1.255	2.877	71.1	1.000
20/18	0.0359	0.0478	4.4	1.251	1.191	1.807	1.791	0.871	1.009	2.074	1.232	2.877	71.1	1.000
18/20	0.0478	0.0359	4.6	1.310	1.265	2.039	1.643	1.106	1.241	1.843	1.270	2.872	71.0	1.000
18/18	0.0478	0.0478	5.1	1.463	1.402	2.222	1.958	1.133	1.135	1.961	1.259	2.872	71.0	1.000
18/16	0.0478	0.0598	5.7	1.616	1.540	2.377	2.266	1.154	1.049	2.059	1.242	2.872	71.0	1.000
16/18	0.0598	0.0478	5.9	1.675	1.614	2.609	2.121	1.389	1.230	1.878	1.271	2.867	70.8	1.000
16/16	0.0598	0.0598	6.4	1.828	1.752	2.793	2.433	1.416	1.148	1.972	1.263	2.867	70.8	1.000

Gage	GRADE 50: F <sub>y</sub> = 50 ksi, F <sub>u</sub> = 65 ksi													
	I <sub>e+</sub> in <sup>4</sup> /ft	I <sub>e-</sub> in <sup>4</sup> /ft	I <sub>d+</sub> in <sup>4</sup> /ft	I <sub>d-</sub> in <sup>4</sup> /ft	S <sub>e+</sub> in <sup>3</sup> /ft	S <sub>e-</sub> in <sup>3</sup> /ft	M <sub>n+</sub> k-ft/ft	M <sub>n-</sub> k-ft/ft	M <sub>nx+</sub> k-ft/ft	M <sub>nx-</sub> k-ft/ft	V <sub>n</sub> k/ft	T <sub>n</sub> k/ft	V <sub>nn</sub> k/ft	V <sub>ni</sub> k/ft
20/20	1.464	1.172	1.530	1.335	0.507	0.709	2.113	2.954	6.167	3.550	6.127	52.70	1.283	2.786
20/18	1.593	1.394	1.664	1.532	0.505	0.801	2.104	3.338	7.463	3.629	6.127	59.55	1.180	1.755
18/20	1.913	1.474	1.955	1.662	0.796	0.869	3.317	3.621	6.846	4.608	10.917	63.25	1.417	3.379
18/18	2.080	1.699	2.127	1.873	0.817	1.030	3.404	4.292	8.158	4.721	10.917	70.10	1.951	3.351
18/16	2.221	1.997	2.273	2.124	0.832	1.077	3.467	4.488	9.442	4.808	10.917	77.00	1.826	2.599
16/18	2.549	2.007	2.569	2.208	1.096	1.210	4.567	5.042	8.838	5.788	14.572	80.70	2.103	3.958
16/16	2.727	2.316	2.749	2.475	1.119	1.314	4.663	5.475	10.138	5.900	14.572	87.60	2.707	4.076

R	w <sub>tf</sub>	w <sub>bf</sub>	w <sub>bp1</sub>	S <sub>bp</sub>
in.	in.	in.	in.	in.
0.188	3.523	1.773	8.000	6.000

d <sub>p</sub>	c <sub>p</sub>	P <sub>p</sub>
in.	in.	in.
0.156	0.433	5.569



Non-Embossed Profiles

PLNCD-24 AC, NCD-24 AC

Embossed Profiles

PLNCD-24 AC FormLok,

NCD-24 AC FormLok

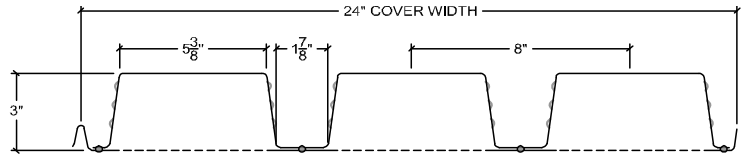

Gage	t in.	t <sub>b</sub> in.	w <sub>dd</sub> psf	A <sub>g</sub> in <sup>2</sup> /ft	A <sub>n</sub> in <sup>2</sup> /ft	I <sub>xg</sub> in <sup>4</sup> /ft	S <sub>ft+</sub> in <sup>3</sup> /ft	S <sub>ft-</sub> in <sup>3</sup> /ft	y <sub>b</sub> in.	y <sub>t</sub> in.	r in.	h <sub>w</sub> in.	θ deg.	K <sub>min</sub> -
20/20	0.0359	0.0359	4.1	1.152	1.108	1.896	1.499	1.049	1.265	1.807	1.308	2.668	82.3	1.000
20/18	0.0359	0.0478	4.6	1.308	1.249	2.085	1.831	1.073	1.139	1.944	1.292	2.668	82.3	1.000
18/20	0.0478	0.0359	4.8	1.376	1.332	2.301	1.651	1.362	1.394	1.689	1.314	2.661	82.1	1.000
18/18	0.0478	0.0478	5.3	1.532	1.474	2.536	1.984	1.395	1.278	1.818	1.312	2.661	82.1	1.000
18/16	0.0478	0.0598	5.8	1.689	1.616	2.736	2.315	1.421	1.182	1.926	1.301	2.661	82.1	1.000
16/18	0.0598	0.0478	6.1	1.757	1.699	2.950	2.135	1.709	1.382	1.726	1.318	2.653	81.9	0.994
16/16	0.0598	0.0598	6.6	1.914	1.841	3.188	2.469	1.743	1.291	1.829	1.316	2.653	81.9	0.994

GRADE 50: F <sub>y</sub> = 50 ksi, F <sub>u</sub> = 65 ksi														
Gage	I <sub>e+</sub> in <sup>4</sup> /ft	I <sub>e-</sub> in <sup>4</sup> /ft	I <sub>d+</sub> in <sup>4</sup> /ft	I <sub>d-</sub> in <sup>4</sup> /ft	S <sub>e+</sub> in <sup>3</sup> /ft	S <sub>e-</sub> in <sup>3</sup> /ft	M <sub>n+</sub> k-ft/ft	M <sub>n-</sub> k-ft/ft	M <sub>nx+</sub> k-ft/ft	M <sub>nx-</sub> k-ft/ft	V <sub>n</sub> k/ft	T <sub>n</sub> k/ft	V <sub>nn</sub> k/ft	V <sub>ni</sub> k/ft
20/20	1.491	1.294	1.626	1.495	0.519	0.706	2.163	2.942	6.246	4.371	6.418	55.40	1.350	2.608
20/18	1.633	1.550	1.784	1.728	0.516	0.909	2.150	3.788	7.629	4.471	6.418	62.45	1.253	1.930
18/20	1.984	1.606	2.090	1.838	0.798	0.852	3.325	3.550	6.879	5.675	11.339	66.60	1.477	3.111
18/18	2.172	1.889	2.293	2.105	0.819	1.055	3.413	4.396	8.267	5.813	11.339	73.70	2.054	3.370
18/16	2.330	2.210	2.465	2.385	0.836	1.318	3.483	5.492	9.646	5.921	11.339	80.80	1.936	2.719
16/18	2.704	2.214	2.786	2.459	1.111	1.199	4.629	4.996	8.896	7.121	14.136	84.95	2.198	3.798
16/16	2.914	2.567	3.005	2.774	1.134	1.475	4.725	6.146	10.288	7.263	14.136	92.05	2.851	4.158

R	w <sub>tf</sub>	w <sub>bf</sub>	w <sub>bp1</sub>	S <sub>bp</sub>
in.	in.	in.	in.	in.
0.188	4.946	1.446	8.000	6.000

d <sub>p</sub>	c <sub>p</sub>	P <sub>p</sub>
in.	in.	in.
0.156	0.433	5.569



**Embossed Profiles**

PLW2CD-36 AC FormLok,  
W2CD-36 AC FormLok

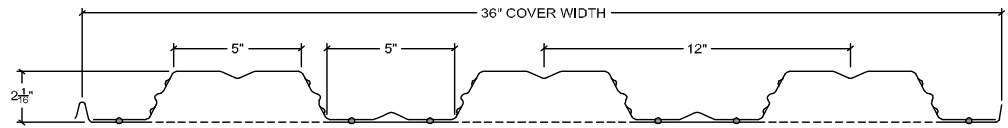

Gage	t in.	t <sub>b</sub> in.	w <sub>dd</sub> psf	A <sub>g</sub> in <sup>2</sup> /ft	A <sub>n</sub> in <sup>2</sup> /ft	I <sub>xg</sub> in <sup>4</sup> /ft	S <sub>ft+</sub> in <sup>3</sup> /ft	S <sub>ft-</sub> in <sup>3</sup> /ft	y <sub>b</sub> in.	y <sub>t</sub> in.	r in.	h <sub>w</sub> in.	θ deg.	K <sub>min</sub> -
20/20	0.0360	0.0359	3.4	0.957	0.920	0.676	1.037	0.456	0.652	1.482	0.857	2.047	63.6	1.000
20/18	0.0360	0.0478	3.8	1.108	1.060	0.726	1.245	0.464	0.583	1.564	0.828	2.047	63.6	1.000
18/20	0.0470	0.0359	3.9	1.109	1.073	0.831	1.143	0.586	0.727	1.419	0.880	2.044	63.5	1.000
18/18	0.0470	0.0478	4.3	1.261	1.212	0.893	1.355	0.596	0.659	1.499	0.858	2.044	63.5	1.000
18/16	0.0470	0.0598	4.8	1.413	1.353	0.946	1.561	0.605	0.606	1.564	0.836	2.044	63.5	1.000
16/18	0.0590	0.0478	4.9	1.427	1.379	1.066	1.472	0.737	0.724	1.446	0.879	2.041	63.3	0.854
16/16	0.0590	0.0598	5.4	1.580	1.519	1.130	1.682	0.749	0.672	1.509	0.863	2.041	63.3	0.854

GRADE 50: F <sub>y</sub> = 50 ksi, F <sub>u</sub> = 65 ksi														
Gage	I <sub>e+</sub> in <sup>4</sup> /ft	I <sub>e-</sub> in <sup>4</sup> /ft	I <sub>d+</sub> in <sup>4</sup> /ft	I <sub>d-</sub> in <sup>4</sup> /ft	S <sub>e+</sub> in <sup>3</sup> /ft	S <sub>e-</sub> in <sup>3</sup> /ft	M <sub>n+</sub> k-ft/ft	M <sub>n-</sub> k-ft/ft	M <sub>nx+</sub> k-ft/ft	M <sub>nx-</sub> k-ft/ft	V <sub>n</sub> k/ft	T <sub>n</sub> k/ft	V <sub>nn</sub> k/ft	V <sub>ni</sub> k/ft
20/20	0.641	0.459	0.653	0.531	0.363	0.420	1.513	1.750	4.321	1.900	3.911	46.00	0.974	1.824
20/18	0.687	0.507	0.700	0.580	0.370	0.439	1.542	1.829	5.188	1.933	3.911	53.00	0.904	1.105
18/20	0.829	0.578	0.830	0.662	0.524	0.539	2.183	2.246	4.763	2.442	5.158	53.65	1.064	2.314
18/18	0.892	0.629	0.892	0.717	0.534	0.561	2.225	2.338	5.646	2.483	5.158	60.60	1.436	1.984
18/16	0.944	0.690	0.945	0.775	0.542	0.579	2.258	2.413	6.504	2.521	5.158	67.65	1.349	1.512
16/18	1.064	0.761	1.065	0.863	0.700	0.690	2.917	2.875	6.133	3.071	6.455	68.95	1.544	2.416
16/16	1.128	0.824	1.129	0.926	0.711	0.712	2.963	2.967	7.008	3.121	6.455	75.95	2.004	2.410

Gage	A <sub>gtf</sub> in <sup>2</sup>	A <sub>stf</sub> in <sup>2</sup>	I <sub>sptf</sub> in <sup>4</sup>	A <sub>gbf</sub> in <sup>2</sup>	A <sub>sbf</sub> in <sup>2</sup>	I <sub>spbf</sub> in <sup>4</sup>
20/xx	0.177	0.043	0.001	0.177	0.043	0.001
18/xx	0.231	0.056	0.002	0.231	0.056	0.002
16/xx	0.289	0.071	0.002	0.289	0.071	0.002

b <sub>otf</sub> in.	b <sub>ptf</sub> in.	c <sub>stf</sub> in.	b <sub>obf</sub> in.	b <sub>pbf</sub> in.	c <sub>sbf</sub> in.
4.696	1.848	2.348	4.696	1.848	2.348

R in.	w <sub>bp1</sub> in.	w <sub>bp2</sub> in.	s <sub>bp</sub> in.
0.188	9.250	2.750	6.000

d <sub>p</sub> in.	c <sub>p</sub> in.	P <sub>p</sub> in.
0.156	0.433	6.868



Embossed Profiles

PLW3CD-36 AC FormLok,

W3CD-36 AC FormLok

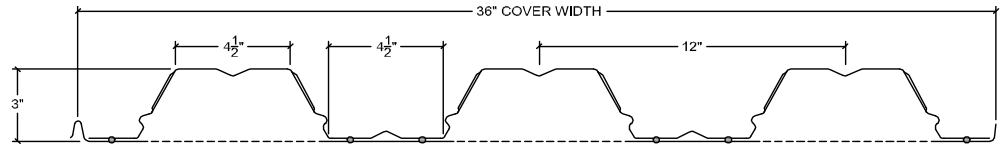

Gage	t in.	t <sub>b</sub> in.	w <sub>dd</sub> psf	A <sub>g</sub> in <sup>2</sup> /ft	A <sub>n</sub> in <sup>2</sup> /ft	I <sub>xg</sub> in <sup>4</sup> /ft	S <sub>ft+</sub> in <sup>3</sup> /ft	S <sub>ft-</sub> in <sup>3</sup> /ft	y <sub>b</sub> in.	y <sub>t</sub> in.	r in.	h <sub>w</sub> in.	θ deg.	K <sub>min</sub> -
20/20	0.0359	0.0359	3.6	1.002	0.965	1.426	1.511	0.670	0.944	2.128	1.216	3.112	63.1	0.000
20/18	0.0359	0.0478	4.0	1.153	1.105	1.531	1.820	0.683	0.841	2.242	1.177	3.112	63.1	0.000
18/20	0.0478	0.0359	4.1	1.182	1.146	1.777	1.683	0.876	1.056	2.028	1.245	3.108	63.0	0.000
18/18	0.0478	0.0478	4.6	1.334	1.285	1.910	1.996	0.893	0.957	2.139	1.219	3.108	63.0	0.000
18/16	0.0478	0.0598	5.0	1.486	1.426	2.021	2.302	0.906	0.878	2.230	1.190	3.108	63.0	0.000
16/18	0.0598	0.0478	5.2	1.515	1.467	2.268	2.168	1.100	1.046	2.062	1.243	3.105	62.9	0.000
16/16	0.0598	0.0598	5.7	1.668	1.608	2.403	2.480	1.117	0.969	2.151	1.222	3.105	62.9	0.000

GRADE 50: F <sub>y</sub> = 50 ksi, F <sub>u</sub> = 65 ksi														
Gage	I <sub>e+</sub> in <sup>4</sup> /ft	I <sub>e-</sub> in <sup>4</sup> /ft	I <sub>d+</sub> in <sup>4</sup> /ft	I <sub>d-</sub> in <sup>4</sup> /ft	S <sub>e+</sub> in <sup>3</sup> /ft	S <sub>e-</sub> in <sup>3</sup> /ft	M <sub>n+</sub> k-ft/ft	M <sub>n-</sub> k-ft/ft	M <sub>nxt+</sub> k-ft/ft	M <sub>nxt-</sub> k-ft/ft	V <sub>n</sub> k/ft	T <sub>n</sub> k/ft	V <sub>nn</sub> k/ft	V <sub>ni</sub> k/ft
20/20	1.424	0.973	1.425	1.124	0.542	0.608	2.258	2.533	6.296	2.792	3.776	48.25	1.379	2.879
20/18	1.527	1.073	1.528	1.226	0.542	0.640	2.258	2.667	7.583	2.846	3.776	55.25	1.267	1.628
18/20	1.775	1.249	1.776	1.425	0.847	0.794	3.529	3.308	7.013	3.650	6.858	57.30	1.525	3.937
18/18	1.908	1.353	1.909	1.539	0.863	0.830	3.596	3.458	8.317	3.721	6.858	64.25	2.097	3.146
18/16	2.020	1.478	2.020	1.659	0.860	0.862	3.583	3.592	9.592	3.775	6.858	71.30	1.961	2.250
16/18	2.266	1.633	2.267	1.845	1.099	1.018	4.579	4.242	9.033	4.583	9.918	73.35	2.264	3.804
16/16	2.401	1.761	2.402	1.975	1.116	1.057	4.650	4.404	10.333	4.654	9.918	80.40	2.910	3.587

Gage	A <sub>gtf</sub> in <sup>2</sup>	A <sub>stf</sub> in <sup>2</sup>	I <sub>sptf</sub> in <sup>4</sup>	A <sub>gbf</sub> in <sup>2</sup>	A <sub>sbf</sub> in <sup>2</sup>	I <sub>spbf</sub> in <sup>4</sup>
20/xx	0.159	0.043	0.001	0.159	0.043	0.001
18/xx	0.211	0.057	0.002	0.211	0.057	0.002
16/xx	0.263	0.072	0.002	0.263	0.072	0.002

b <sub>otf</sub> in.	b <sub>ptf</sub> in.	c <sub>stf</sub> in.	b <sub>obf</sub> in.	b <sub>pbf</sub> in.	c <sub>sbf</sub> in.
4.198	1.599	2.099	4.198	1.599	2.099

R in.	w <sub>bp1</sub> in.	w <sub>bp2</sub> in.	s <sub>bp</sub> in.
0.188	9.250	2.750	6.000

d <sub>p</sub> in.	c <sub>p</sub> in.	P <sub>p</sub> in.
0.156	0.433	6.868